

# C1





TRACTOR MODEL	ENGINE TYPE	CYLINDERS	CYLINDER DIAMETER
SOM35, SOM45, SOM50	OM CO1D	4	105
SOM40, SOM55	OM CO2D	4	108
SOM511, SOM512	OM CO1D/45	4	105
SOM612, SOM615	OM CO2S	4	108
SOM650	OM CN 3	3	110
SOM670	OM CO 3/60	4	110
SOM715	OM CO 3D/130	4	110
SOM750	OM CO 3/70	4	110
SOM800, SOM805C, SOM880/4	OM CO 3/75	4	110
SOM850	OM CO 3/80	4	110
SOM1300	OM CP3/100	6	110
250, 255, 300	8025.01	2	95
311, 311R, 312, 312R, 315	605D	4	82
350	8025.02	2	100
400, 420, 450, 460, 470	8035.01	3	95
411, 411R, 412, 412R, 415, 421, 431	615D	4	85
440, 446, 450, 455C, 466, 474, 480, 500, 505C	8035.02	3	100
505C SUPER, 565C, 566, 570, 580	8035.04	3	103
540	8035.02D	3	100
550	8045.01	4	95
600, 605C, 640, 665C, 666, 670, 680	8045.02	4	100
766, 780, 855C	8045.04	4	103
880/5, 955C	8055.04	5	103
900	8065.01	6	95
980, 1000	8065.02	6	100
1000S, 1000SUP, 1180	8065.04	6	103
1280, 138	8065.24 TURBO	6	103
1355C	8365.05	6	115
<b>SERIE 46</b>			
1580, 1880	8365.25 TURBO	6	115
55-46	8035.06	3	100
60-46	8035.05	3	104
65-46	8045.06	4	100
<b>SERIE 55</b>			
85-55C	8045.05	4	104
95-55	8055.05	5	104
100-55	8065.06	6	100
160-55C, 180-55C	8365.25 TURBO	6	115
<b>SERIE 56</b>			
55-56	8035.06	3	100
60-56L	8035.05	3	104
65-56L, 70-56L	8045.06	4	100
<b>SERIE 76</b>			
45-76V, 55-76V, 55-76F	8035.06	3	100
60-76F	8035.05	3	104
70-76LP, 70-76F, 70-76V	8045.06	4	100
80-76F	8045.05	4	104
<b>SERIE 85</b>			
55-85CF, 55-85V, 55-85M	8035.06	3	100
60-85CF, 60-85CV, 62-85C, 62-85CM	8035.05	3	104
72-85C, 72-85CM	8045.06	4	100
82-85C, 88-85C	8045.05	4	104
88-85M	8045.25 TURBO	4	104
<b>SERIE 86</b>			
50-86V	8035.06	3	100
60-86V, 60-86F, 62-86F	8035.05	3	104
70-86V, 72-86F, 72-86LP	8045.06	4	100
82-86F, 82-86LP	8045.05	4	104

TRACTOR MODEL	ENGINE TYPE	CYLINDERS	CYLINDER DIAMETER
<b>SERIE 88</b>			
55-88	8035.06	3	100
60-88	8035.05	3	104
65-88, 70-88	8045.06	4	100
80-88	8045.05	4	104
<b>SERIE 90</b>			
55-90	8035.06	3	100
60-90	8035.05	3	104
65-90, 70-90	8045.06	4	100
80-90	8045.05	4	104
85-90	8045.25 TURBO	4	104
90-90	8055.05	5	104
100-90	8065.06	6	100
110-90, 115-90	8065.05	6	104
130-90, 140-90	8065.25 TURBO	6	104
160-90, 180-90	8365.25 TURBO	6	115
<b>SERIE 93</b>			
60-93	8035.05	3	104
65-93, 72-93	8045.06	4	100
82-93	8045.05	4	104
88-93	8045.25 TURBO	4	104
<b>SERIE 94</b>			
60-94	8035.05	3	104
65-94, 72-94	8045.06	4	100
82-94	8045.05	4	104
88-94	8045.25 TURBO	4	104
<b>SERIE 65</b>			
55-65F, 55-65V, 55-65M	8035.06	3	100
60-65CM, 60-65CV	8035.05	3	104
70-65C	8045.06	4	100
<b>SERIE 66</b>			
35-66	CHD 1503	3	88
45-66, 45-66V, 50-66S, 55-66	8035.06	3	100
60-66	8035.05	3	104
65-66, 70-66, 70-66LP, 70-66F	8045.06	4	100
80-66, 80-66F	8045.05	4	104
<b>SERIE 75</b>			
55-75CF, 55-75M	8035.06	3	100
60-75CV, 60-75CM	8035.05	3	104
70-75C, 70-75CM	8045.06	4	100
80-75C	8045.05	4	104
<b>SERIE WINNER</b>			
F100 FINO	8065.06	6	100
F100DAL, F110, F120	8065.05	6	104
F115	8065.05R	6	104
F130	8065.25 TURBO	6	104
F140	8065.25 S TURBO	6	104
<b>SERIE L</b>			
L60	8035.05	3	104
L65	8045.06	4	100
L75	8045.05	4	104
L85	8045.25 TURBO	4	104
L95	8045.05K TURBO	4	104
<b>SERIE G</b>			
G170=8670			
G190=8770			
G210=8870			
G240=8970			
<b>SERIE M</b>			
M100=8160			
M115=8260			
M135=8360			
M160=8560			

08.05.2009

Fiat engine overhaul kits STD include:

- pistons
- piston rings
- liners (semi-finished)
- complete gasket set
- front and rear crankshaft seals  
(if not incl. in gasket set)
- conrod bearings STD
- main bearings STD



TRACTOR MODEL	ENGINE OVERHAUL KIT STD (a)	COMPLETE PISTON	PISTON RING SET	LINER
411, 415		<b>T3167</b> (d) 1909866	<b>T3170</b> 1909861	<b>T3168</b> 561212
450, 550			<b>T3169</b> 1901496	
500			<b>T3140</b> 1908737	
600, 640	<b>K0200</b> (c)	<b>T3129</b> (c, d) 1908744	<b>T3140</b> 1908737	<b>T3136</b> 4653280
650, 750, 850			<b>T3141</b> 1909236	
1000		<b>T3129</b> (c, d) 1908744	<b>T3140</b> 1908737	<b>T3136</b> 4653280
1000 Super, 580		<b>T3131</b> 1908748	<b>T3142</b> 1909234	<b>T3138</b> 4679201
1300, 1300 Super			<b>T3141</b> (b) 1909236	
680	<b>K0200</b>	<b>T3129</b> (d) 1908744	<b>T3140</b> 1908737	<b>T3136</b> 4653280
780	<b>K0201</b>	<b>T3131</b> 1908748	<b>T3142</b> 1909234	<b>T3138</b> 4679201
880-4 cyl.	<b>K0202</b>		<b>T3141</b> 1909236	
880-5 cyl.	<b>K0203</b>	<b>T3131</b> 1908748	<b>T3142</b> 1909234	<b>T3138</b> 4679201
980		<b>T3129</b> (d) 1908744	<b>T3140</b> 1908737	<b>T3136</b> 4653280
1180		<b>T3131</b> 1908748	<b>T3142</b> 1909234	<b>T3138</b> 4679201
1380				<b>T3138</b> 4679201
1580		<b>T3134</b> (d) 1901492	<b>T3144</b> 1901487	<b>T3139</b> 2991786
1880, 1580T			<b>T3257</b> 1930753	<b>T3139</b> 2991786

a - set includes liners, pistons, piston rings, conrod bearings, main bearings and gaskets

b - four rings

c - combustion chamber in the middle in later than 1978, piston pin diameter 32 mm

d - includes piston rings



08.05.2009

Fiat engine overhaul kits STD include:

- pistons
- piston rings
- liners (semi-finished)
- complete gasket set
- front and rear crankshaft seals (if not incl. in gasket set)
- conrod bearings STD
- main bearings STD



TRACTOR MODEL	ENGINE OVERHAUL KIT STD	COMPLETE PISTON	PISTON RING SET	CYLINDER
55-90, 65-90, 70-90		<b>T3251</b> (c) 1930241	<b>T3255</b> 1908738	<b>T3319</b> 4770654
60-90, 90-90, 115-90, 110-90		<b>T3252</b> (c) 1930186	<b>T3256</b> 1930191	<b>T3320</b> 4770623
80-90	K0205	<b>T3252</b> (c) 1930186	<b>T3256</b> 1930191	<b>T3320</b> 4770623
100-90		<b>T3251</b> (c) 4770654	<b>T3255</b> 1908738	<b>T3319</b> 4770654
130-90, 140-90		<b>T3253</b> (b, c) 2991530	<b>T3258</b> 1902687	<b>T3320</b> 4770623
160-90 →26250			<b>T3257</b> 1930753	<b>T3139</b> 2991786
180-90 →26250			<b>T3257</b> 1930753	<b>T3139</b> 2991786
160-90 26251→		<b>T3723</b> (a) 1930742	<b>T3257</b> 1930753	<b>T3139</b> 2991786
180-90 26251→		<b>T3723</b> (a) 1930742	<b>T3257</b> 1930753	<b>T3139</b> 2991786
L60, L75		<b>T3252</b> (c) 1930186	<b>T3256</b> 1930191	<b>T3320</b> 4770623
L65		<b>T3251</b> (c) 1930241	<b>T3255</b> 1908738	<b>T3319</b> 4770654

a - combustion chamber chamfered from the valve side

b - new piston reinforced from upper end so that the upper end of conrod must be narrowed

c - includes piston rings

25.07.2008

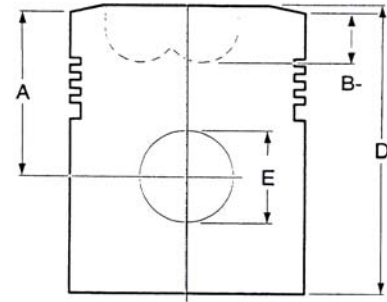
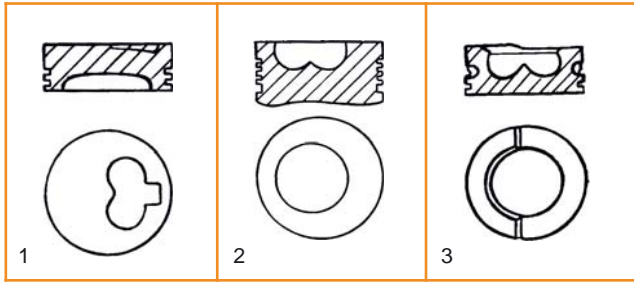









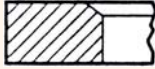







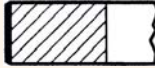







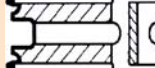



A Compression height mm  
 B- Combustion chamber depth mm  
 D Overall length mm  
 E Piston pin diameter mm  
 F Piston pin length mm

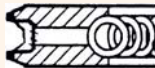

ORDER NUMBER	MOTOR TYPE	∅	MODEL	PCS	STEEL REINFORCED	A	B-	D	E	F
<b>T3167</b> 1909866	615D	85	1	4		50,3	4,5	90	28	74,4
	8025.01 8035.01 8045.01	95	2	3		59,6	23,5	101,5	32	84
	8025.02 8035.02 8045.02 8065.02	100	2	3		59,6	23,7	101,15	32	84
<b>T3251</b> 1930241	8035.06 8045.06 8065.06	100	2	3		65,15	22,7	108,5	38	85
<b>T3131</b> 1908748	8035.04 8045.04 8055.04 8065.04	103	2	3		59,6	22,7	101,15	34	90
<b>T3252</b> 1930186	8035.05 8045.05 8055.05 8065.05	104	2	3		65,15	22,5	108,5	38	85
<b>T3253</b> 1930206	8045.25 8065.25	104	2	3	yes	65,15	22,5	108,5	38	89
<b>T3134</b> 1901492	8365.05	115	2	3	yes	76,5	29,4	140,5	42	97
<b>T3723</b> 1930742	8361.45	115	3	3	yes	76,5	27,7	140,5	42	97

06.10.2006

ORDER NUMBER	ENGINE TYPE	Ø mm				
<b>T3169</b> 1901496	8025.01 8035.01 8045.01	95	 2,5	 2,5	 5,5	
<b>T3140</b> 1909172	8025.02 8035.02 8045.02 8065.02	100	 2,5	 2,5	 5,5	
<b>T3142</b> 1909234	8035.04 8045.04 8055.04 8065.04	103	 2,5	 2,5	 4,0	
<b>T3256</b> 1930191	8035.05 8045.05 8055.05 8065.05	104	 2,5	 2,5	 4,0	
<b>T3255</b> 1930169	8035.06 8045.06 8065.06	100	 2,5	 2,5	 4,0	
<b>T3170</b> 1909861	615D	85	 3,0	 3,0	 3,0	 5,5
<b>T3258</b> 1930209	8045.25 8065.25	104	 3,0	 2,5	 4,0	
	8065.25	104	 3,0	 2,5	 4,0	
<b>T3144</b> 1901487	8365.05	115	 2,5	 2,5	 4,0	
<b>T3257</b> 1930753	8365.25	115	 3,0	 2,5	 4,0	

04.02.2008

- A - nominal bore diameter mm
- B - outer diameter mm
- C - flange diameter mm
- D - flange width mm
- E - overall length mm

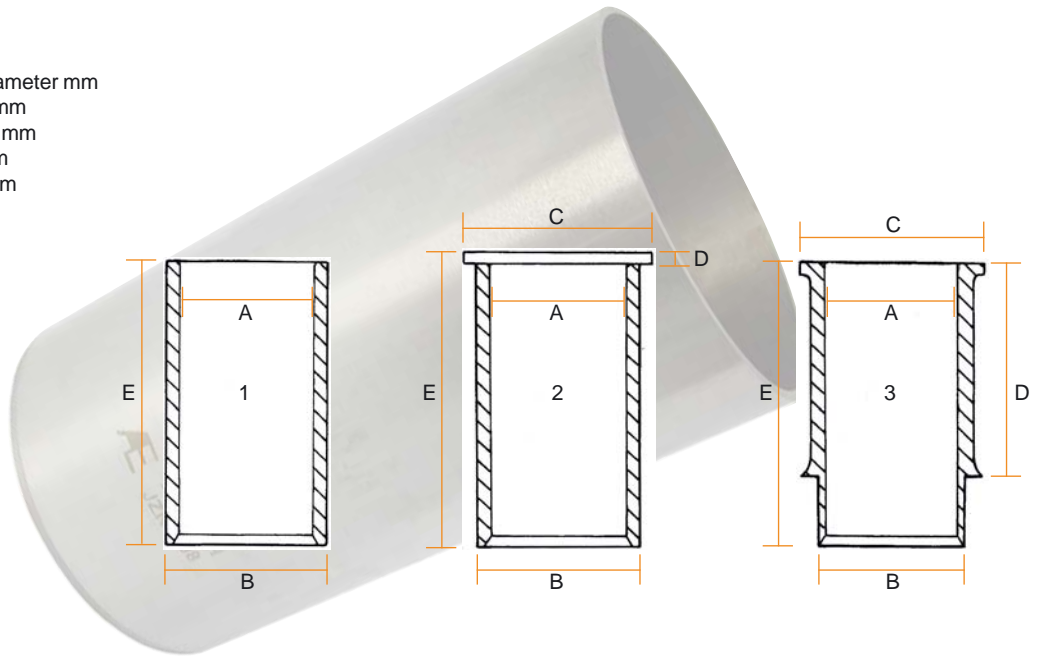

ORDER NUMBER	MODEL	A mm	B mm	C mm	D mm	E mm
<b>T3168</b> 561212	1	85	90,4			178
	1	95	99,1			187
<b>T3136</b> 4653280	1	100	103,06			187
<b>T3319</b> 4770654	1	100	103,06			196
<b>T3138</b> 4679201	1	103	107,1			187
<b>T3320</b> 4770623	1	104	107,1			198
	2	104	107,05	109,87	5	198
<b>T3139</b> 4850230	3	115	122	129,7	167	235

06.10.2006



T3145



T3279



T3276

TRACTOR MODEL	CONROD BEARING PAIR (a)	MAIN BEARING PAIR (a)	THRUST BEARING SET
640	T3145 x 4 1901609	T3279 x 5 1901803	T3275 (e) 1909996 T3276 (b) 1901377
640	T3145 x 4 1901609	T3279 x 5 1901803	T3275 (e) 1909996 T3276 (b) 1901377
780	T3145 x 4 1901609	T3279 x 5 1901803	T3275 (e) 1909996 T3276 (b) 1901377
750, 880 - 4 syl.	T3146 x 4 1901614		T3277 1901624
1000 Super, 980, 1180 6 cyl.	T3145 x 6 1901609	T3279 x 7 1901803	T3276 (b) 1901377



T3145



T3279



T3276



T3270

TRACTOR MODEL	CONROD BEARING PAIR (a)	MAIN BEARING PAIR (a)	COMPL. MAIN BEARING SET (a)	THRUST BEARING SET	SMALL END BUSH
312, 315	T3285 1909905				
411, 415, 441	T3286 1909856		T3288 1909893	T3290 902302	
450, 550	T3145 1901609	T3279 1901803		T3275 1909996	
600, 640	T3145 1901609	T3279 1901803		T3276 (b) 1901377	
650	T3146 1901614		T3292 1909459	T3277 1901624	
750, 850	T3146 1901614			T3277 1901624	
1000	T3145 1901609	T3279 1901803		T3275 1909996	
1000 Super	T3145 1901609	T3279 1901803		T3276 1901377	T3270 (d) 4754066
1300, 1300 Super	T3146 1901614		T3281 1901244	T3277 1901624	

a - also undersize bearings

b - from 1977

d - dimensions: T3270 37,9 x 34 mm

e - models 1971-1976



25.07.2008

### Note!

T3282 main bearing set:  
Check oil holes position!  
(see picture below)

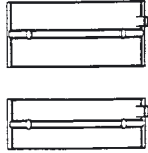

T3145



T3283



T3278



T3270

TRACTOR MODEL	CONROD BEARING PAIR (e)	MAIN BEARING PAIR (e)	COMPL. MAIN BEARING SET (e)	THRUST BEARING SET	SMALL END BUSH (g)
580	T3145 1901609	T3279 1901803		T3275 (h) 1909996 T3276 (f) 1901377	T3270 4754066
680	T3145 1901609	T3279 1901803		T3275 (h) 1909996 T3276 (f) 1901377	
780	T3145 1901609	T3279 1901803		T3275 (h) 1909996 T3276 (f) 1901377	T3270 4754066
880, 4-cyl.	T3146 1901614			T3277 1901624	
880, 5-cyl.	T3145 1901609	T3279 1901803		T3276 1901377	T3270 4754066
980	T3145 1901609	T3279 1901803		T3276 1901377	
1180, 1380	T3145 1901609	T3279 1901803		T3276 1901377	T3270 4754066
1580, 1880 1580 turbo	T3147 (c) 1901619		T3282 1901832	T3278 1901385	T3272 (b) 4771030
55-90, 60-90, 65-90, 70-90	T3266 1930181	T3283 1930176		T3278 1901385	T3273 4766404
80-90, 90-90, 100-90	T3266 1930181	T3283 1930176		T3278 1901385	T3273 4766404
115-90, 130-90	T3266 1930181	T3283 1930176		T3278 1901385	T3273 4766404
140-90	T3267 1930201	T3283 1930176		T3278 1901385	T3274 4783226
160-90, 180-90	T3268 (d) 1901993 tai T3147 (c) 1901619		T3282 1901832	T3278 1901385	T3272 4771030

b - 1580 from engine number 702097→, 1880 from engine number 750749→

c - T3147 equipped with oil hole up to engine number →702096

d - T3268 without oil hole from engine number 702097→

e - also undersize bearings

f - from model 1977→

g - dimensions 37,9 x 34 mm

h - models 1971-1976

08.05.2009

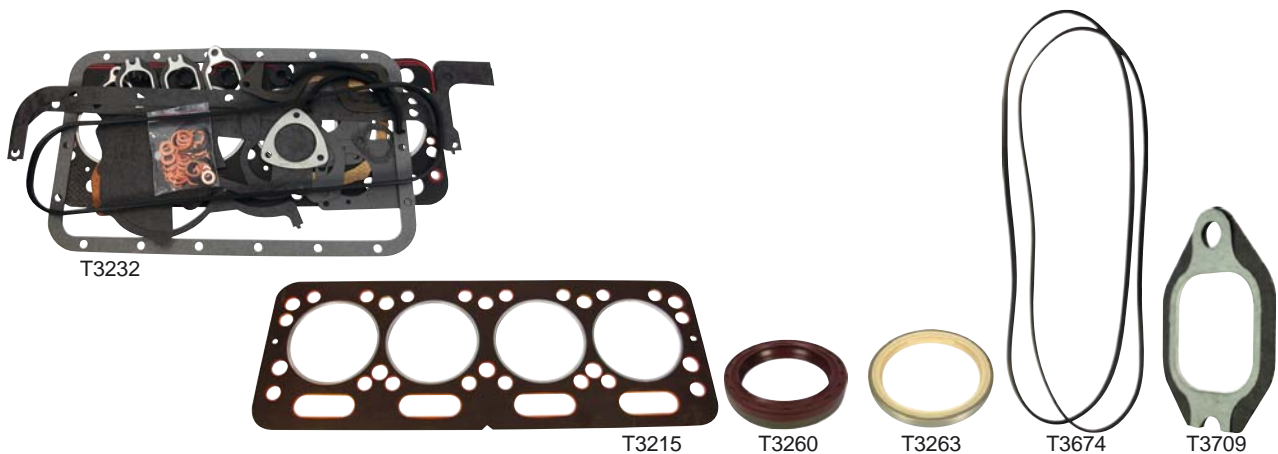

TRACTOR MODELS	COMPL. GASKET SET	CYLINDER HEAD GASKET	TIMING COVER OIL SEAL	REAR MAIN OIL SEAL	ROCKER COVER GASKET	MANIFOLD GASKET
312, 315	T3293	T3296				
411, 415, 441	T3294 (e,f)	T3297				
450			<b>T3259</b> 98461684	<b>T3262 (a)</b> 40000720		
640	<b>T3232</b> 1909567	<b>FT98472008</b> 98472008	<b>T3259</b> 98461684	<b>T3262 (a)</b> 40000720 <b>T3263 (b)</b> 40002811 <b>T3265 (d)</b> 98461686	<b>T3672</b> 4654363	<b>T3709</b> 4601981
650	<b>T3318 (e,f)</b> 1909565		<b>T3260</b> 40101393			
750		<b>T3215</b> 8818558	<b>T3260</b> 38819123		<b>T3675</b> 8816531	
850		<b>T3215</b> 8818558	<b>T3260</b> 38819123		<b>T3675</b> 8816531	
1000		<b>FT98472010</b> 98472010	<b>T3259</b> 98461684	<b>T3262 (a)</b> 40000720 <b>T3263 (b)</b> 40002811	<b>T3674</b> 4628453	<b>T3709</b> 4601981
1000 Super	<b>T3242</b> 1909543	<b>FT98456219 (c)</b> 98456219	<b>T3259</b> 98461684	<b>T3263 (b)</b> 40002811	<b>T3674</b> 4628453	<b>T3709</b> 4601981
1300			<b>T3260</b> 38819123		<b>T3676</b> 8829321	
1300 Super			<b>T3260</b> 38819123		<b>T3676</b> 8829321	

a - 95 x 120 x13

b - 110 x 135 x 13

c - alternative original **FT98456219**

d - 114 x 135 x 13

e - gasket set doesn't include rear main oil seal

f - gasket set doesn't include timing cover oil seal

08.05.2009

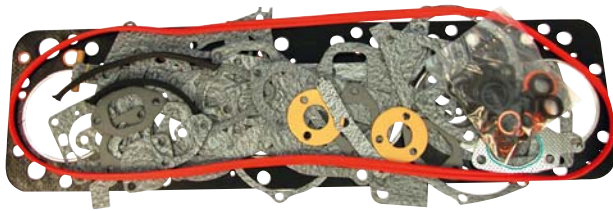

T3249



T3220



T3259



T3265



T3674



T3709

TRACTOR MODELS	COMPL. GASKET SET	CYLINDER HEAD GASKET	TIMING COVER OIL SEAL	REAR MAIN OIL SEAL	ROCKER COVER GASKET	MANIFOLD GASKET
580	<b>T3231</b> 1909590	<b>T3216</b> 4708955	<b>T3259</b> 98461684	<b>T3263 (c)</b> 40002811	<b>T3671</b> 4783243	<b>T3709</b> 4601981
680	<b>T3232 (e,f)</b> 1909567	<b>FT98472008</b> 98472008	<b>T3259</b> 98461684	<b>T3263 (c)</b> 40002811	<b>T3672</b> 4654363	<b>T3709</b> 4601981
780	<b>T3233</b> 1909983	<b>FT98456215</b> 98456215	<b>T3259</b> 98461684	<b>T3263 (c)</b> 40002811	<b>T3672</b> 4654363	<b>T3709</b> 4601981
880, 4-cyl.	<b>T3149 (e,f)</b> 1909551	<b>T3215</b> 8818558	<b>T3260</b> 8831405		<b>T3675</b> 8816531	
880, 5-cyl.	<b>T3235</b> 1930273		<b>T3259</b> 98461684	<b>T3263 (c)</b> 40002811	<b>T3673</b> 4783242	<b>T3709</b> 4601981
980		<b>FT98472010</b> 98472010	<b>T3259</b> 98461684	<b>T3263 (c)</b> 40002811	<b>T3674</b> 4628453	<b>T3709</b> 4601981
1180	<b>T3245 (e,f)</b> 1909543	<b>T3224 (a)</b> 4696355	<b>T3259</b> 98461684	<b>T3263 (c)</b> 40002811	<b>T3674</b> 4628453	<b>T3709</b> 4601981
1380		<b>T3224 (a)</b> 4696355	<b>T3259</b> 98461684	<b>T3263 (c)</b> 40002811	<b>T3674</b> 4628453	<b>T3709</b> 4601981
1580		<b>FT4845364</b> 4845364	<b>T3260</b> 8831405	<b>T3264</b> 40101400	<b>T3676</b> 8829321	
1880	<b>T3248</b> 1930369	<b>FT4845364</b> 4845364	<b>T3260</b> 8831405	<b>T3264</b> 40101400	<b>T3676</b> 8829321	
55-90			<b>T3259</b> 98461684	<b>T3265 (d)</b> 98461686	<b>T3671</b> 4783243	<b>T3709</b> 4601981
60-90			<b>T3259</b> 98461684	<b>T3265 (d)</b> 98461686	<b>T3671</b> 4783243	<b>T3709</b> 4601981
70-90, 65-90	<b>T3238 (e,f)</b> 1909563	<b>FT98472008</b> 98472008	<b>T3259</b> 98461684	<b>T3265 (d)</b> 98461686	<b>T3672</b> 4654363	<b>T3709</b> 4601981
80-90	<b>T3239 (e,f)</b> 1930248	<b>FT98456215</b> 98456215	<b>T3259</b> 98461684	<b>T3265 (d)</b> 98461686	<b>T3672</b> 4654363	<b>T3709</b> 4601981
90-90		<b>FT1940075</b> 1940075	<b>T3259</b> 98461684	<b>T3265 (d)</b> 98461686	<b>T3673</b> 4783242	<b>T3709</b> 4601981
100-90	<b>T3249 (e,f)</b> 1930859	<b>FT98472010</b> 98472010	<b>T3259</b> 98461684	<b>T3265 (d)</b> 98461686	<b>T3674</b> 4628453	<b>T3709</b> 4601981
115-90, 130-90, 140-90	<b>T3250 (e,f)</b> 1940051	<b>T3224 (a)</b> 4696355	<b>T3259</b> 98461684	<b>T3265 (d)</b> 98461686	<b>T3674</b> 4628453	
160-90, 1580 turbo	<b>T3669</b> 1930369	<b>FT4845364</b> 4845364	<b>T3260</b> 8831405	<b>T3264</b> 40101400	<b>T3676</b> 8829321	
180-90	<b>T3248</b> 1930369	<b>FT4845364</b> 4845364	<b>T3260</b> 8831405	<b>T3264</b> 40101400	<b>T3676</b> 8829321	
110-90	<b>T3250 (e,f)</b> 1940051	<b>T3224 (a)</b> 1909612	<b>T3259</b> 98461684	<b>T3265 (d)</b> 98461686	<b>T3674</b> 4628453	<b>T3709</b> 4601981
F110, 115, 120, 130	<b>T3250 (e,f)</b> 1940051	<b>T3224 (a)</b> 1909612	<b>T3259</b> 98461684	<b>T3265 (d)</b> 98461686		
F140		<b>T3224 (a)</b> 1909612	<b>T3259</b> 98461684	<b>T3265 (d)</b> 98461686		

a - alternative original **FT98456219**

c - 110 x 135 x 13

d - 114 x 135 x 13

e - gasket set doesn't include rear main oil seal

f - gasket set doesn't include timing cover oil seal

**C1.10**

06.10.2006



T3311



T3312



T3315



T3727

TRACTOR MODELS	INLET VALVE	EXHAUST VALVE	INLET GUIDE	EXHAUST GUIDE	VALVE SPRING
411, 412, 415, 421, 431	<b>T3303</b> 4579416	<b>T3304</b> 4579417			
450, 550, 600, 640, 1000, 1000 Super	<b>T3299</b> 4621511	<b>T3300</b> 4673608	<b>T3315</b> 4684422	<b>T3315</b> 4684422	<b>T3726</b> 4689554
650, 750, 850	<b>T3301</b> 8823545	<b>T3302</b> 8823544	<b>T3316</b> 4758794	<b>T3317</b> 4758798	
1300, 1300 Super		<b>T3302</b> 8823544	<b>T3316</b> 4758794	<b>T3317</b> 4758798	
580, 680, 780, 880 5-cyl., 980, 1180	<b>T3299</b> 4621511	<b>T3300</b> 4673608	<b>T3315</b> 4684422	<b>T3315</b> 4684422	<b>T3726</b> 4689554
880 4-cyl.	<b>T3301</b> 8823545	<b>T3302</b> 8823544	<b>T3316</b> 4758794	<b>T3317</b> 4758798	
1380	<b>T3307</b> 4621511	<b>T3308</b> 4673608	<b>T3315</b> 4684422	<b>T3315</b> 4684422	
1580, 1880, 1580T	<b>T3309</b> 4821709	<b>T3310</b> 8830045	<b>T3316</b> 4758794	<b>T3317</b> 4758798	
55-90, 60-90, 65-90, 70-90,80-90, 85-90, 90-90, 100-90, 110-90, 115-90, 130-90, 140-90	<b>T3311</b> 4824417	<b>T3312</b> 4784889	<b>T3315</b> 4684422	<b>T3315</b> 4684422	<b>T3727</b> 4780108
160-90, 180-90	<b>T3309</b> 4821709	<b>T3310</b> 8830045	<b>T3316</b> 4758794	<b>T3317</b> 4758798	



08.05.2009



**7 good reasons  
to change new nozzles:**

1. saves fuel
2. engine's longer service life
3. cleaner exhaust
4. more power
5. higher torque
6. better start-up
7. smoother running



SD72061



T3115



T3063

TRACTOR MODEL	INJECTOR NOZZLE	COMPARABLE	MOTOR OIL PUMP	OIL PRESSURE SWITCH
450, 640	<b>SD72031</b> 4760843	DLL140S64F	<b>T3115</b> 4705827	<b>T3063</b> 4151243
850	<b>SD72024</b> 4758260	DLL150S51F		
1000	<b>SD72031</b> 4760843	DLL140S64F		<b>T3063</b> 4151243
1300	<b>SD72024</b> 4758260	DLL150S51F		<b>T3063</b> 4151243
580, 680, 780	<b>SD72031</b> 4760843	DLL140S64F	<b>T3115</b> 4705827	<b>T3063</b> 4151243
880 4-cyl.	<b>SD72024</b> 4758260	DLL150S51F		<b>T3063</b> 4151243
880 5-cyl., 980, 1180	<b>SD72031</b> 4760843	DLL140S64F		<b>T3063</b> 4151243
1380	<b>SD72031</b> 4760843	DLL140S64F		<b>T3063</b> 4151243
1580, 1880, 1580T	<b>SD72039</b> 4750416	DLL145S73F		<b>T3063</b> 4151243
55-90, 70-90	<b>SD72060</b> 4791689	DLL124S500W	<b>T3115</b> 4705827	<b>T3063</b> 4151243
60-90, 80-90	<b>SD72061</b> 4776715	DLL136S501W	<b>T3115</b> 4705827	<b>T3063</b> 4151243
90-90, 100-90, 115-90, 130-90, 140-90	<b>SD72061</b> 4776715	DLL136S501W DLL136S1000	<b>T3353</b> 4770250	<b>T3063</b> 4151243
160-90, 180-90	<b>SD72039</b> 4750416	DLL145S73F		<b>T3063</b> 4151243
F100, F110, F120, F130, F140		DLLA137S1208	<b>T3353</b> 4770250	<b>T3063</b> 4151243
446, 450, 45-66, 460, 466, 470, 480, 480-8F, 500, 50-66, 540, 550, 55-66, 55-66F, 55-76F, 55-90, 566, 570, 580, 600, 60-60, 60-66, 60-66F, 60-76F, 60-90, 60-93, 60-94, 640, 65-66, 65-90, 65-93, 65-94, 666, 670, 680, 70-66, 70-66F, 70-76F, 70-90, 72-93, 72-94, 766, 780, 80-66, 80-66F, 80-76F, 80-90, 82-93, 82-94			<b>T3115</b> 4705827	
110-90, 55-65, 55-66, 55-90, 60-65, 60-90, 65-90, 70-65, 70-90, 80-65, 80-66, 80-90, 85-55, 90-90, 95-55				<b>T3063</b> 4151243

08.01.2007

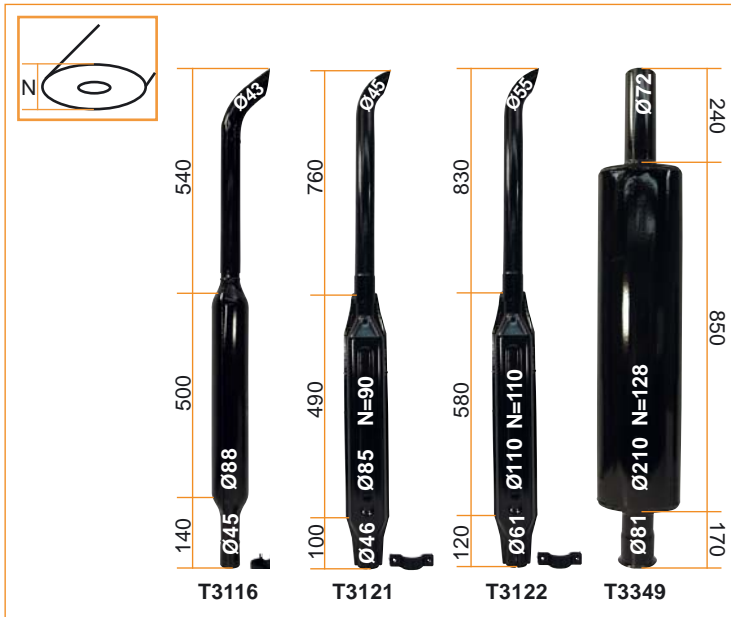

TRACTOR MODEL	EXHAUST PIPE	EXHAUST CLAMP	FUEL TANK CAP	FUEL TANK ARMATURE	FUEL LIFT PUMP	INLET MANIFOLD
450, 640	<b>T3116</b> 5011631		<b>T3344</b> 5118532		<b>T3113</b> 4757883	<b>T3062</b> 5161845
750	<b>T3122 (b)</b> 5101811	<b>T3614</b> 5116798	<b>T3344</b> 5118532		<b>T3183 (a)</b> 763150	
850	<b>T3122 (b)</b> 5101811	<b>T3614</b> 5116798			<b>T3183 (a)</b> 763150	
1000	<b>T3122 (b)</b> 5101811	<b>T3614</b> 5116798			<b>T3114</b> 4709284, 4757884	<b>T3062</b> 5161845
1300	<b>T3122 (b)</b> 5101811	<b>T3614</b> 5116798	<b>T3061</b> 5105346		<b>T3183 (a)</b> 763150	<b>T3062</b> 5161845
580, 680, 780	<b>T3121</b> 4997328	<b>T3613</b> 5116798	<b>T3061</b> 5105346	<b>T3024</b> 5136771	<b>T3113</b> 4757883	<b>T3062</b> 5161845
880 4-cyl., 880 5-cyl., 980	<b>T3122 (b)</b> 5101811	<b>T3614</b> 5116798	<b>T3061</b> 5105346	<b>T3024</b> 5136771	<b>T3114</b> 4709284, 4757884	<b>T3062</b> 5161845
1180	<b>T3122 (b)</b> 5101811	<b>T3614</b> 5116798	<b>T3061</b> 5105346	<b>T3334</b> 5136772	<b>T3114</b> 4709284, 4757884	<b>T3062</b> 5161845
1380	<b>T3122 (b)</b> 5101811	<b>T3614</b> 5116798	<b>T3061</b> 5105346	<b>T3334</b> 5136772	<b>T3342</b> 4709284	<b>T3062</b> 5161845
1580	<b>T3349</b> 5109906		<b>T3061</b> 5105346	<b>T3334</b> 5136772	<b>T3183 (a)</b> 763150	<b>T3062</b> 5161845
1880 160-90, 180-90	<b>T3349</b> 5109906		<b>T3061</b> 5105346	<b>T3334</b> 5136772		<b>T3062</b> 5161845
55-90, 60-90, 70-90, 80-90, 65-90	<b>T3121</b> 4997328	<b>T3613</b> 5116798	<b>T3061</b> 5105346	<b>T3024</b> 5136771	<b>T3113</b> 4757883	<b>T3062</b> 5161845
90-90, 100-90, 110-90	<b>T3122 (b)</b> 5101811	<b>T3614</b> 5116798	<b>T3061</b> 5105346	<b>T3024</b> 5136771	<b>T3114</b> 4709284, 4757884	<b>T3062</b> 5161845
115-90	<b>T3122 (b)</b> 5101811	<b>T3614</b> 5116798	<b>T3061</b> 5105346	<b>T3024</b> 5136771		<b>T3062</b> 5161845
130-90, 140-90	<b>T3122 (b)</b> 5101811	<b>T3614</b> 5116798	<b>T3061</b> 5105346	<b>T3334</b> 5136772		<b>T3062</b> 5161845
F100, F110, F120, F130					<b>T3728</b> 98419724	<b>T3062</b> 161845
L60, L65, L75, L85, L95 TL65, TL70, TL80, TL90, TL100					<b>T3113</b> 4757883	

a - glass bowl for fuel lift pump T5113 Ø 39 mm, height 52 mm  
b - T3122A straight top pipe

## FUEL BOWL

V299



17,5 mm

## FUEL LIFT PUMP

F82006984

82006984  
- electric  
- fits M100, M115, M135, M160



25.07.2008

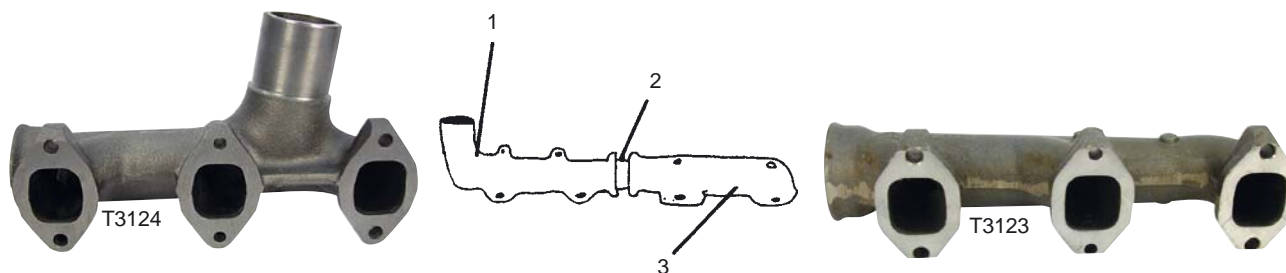

TRACTOR MODEL	1 FRONT PART	2 COUPLING	3 REAR PART
980, 1180, 100-90, 110-90	<b>T3124</b> 4717758	<b>T3125</b> 4602270	<b>T3123</b> 4817497
880-5 syl., 90-90, 115-90	<b>T3124</b> 4717758	<b>T3125</b> 4602270	

## WATER PUMPS

**T3054**

566997  
- 411, 415



**T3055**

4679242  
- 450, 500, 550, 600, 640,  
1000, 480, 880 5-cyl.,  
980, 1180, 1380



**T3198**

8829787  
- 650, 750, 850



**T3195**

4696707  
- 580, 680, 780



**T3197**

8829790  
- 880 4 cyl.



**T3200**

4796534  
- 1580, 1880, 160-90,  
180-90



**F0664**

87801641  
- M100, 115, 135, 160  
TM120, 130, 140



**T3196**

4784454, 98403016,  
4813370  
- →12/92:45-66, 50-66, 55-46,  
55-65, 55-66, 55-90, 60-46,  
60-65, 60-66, 60-90, 65-46,  
65-66, 65-90, 70-65, 70-66,  
70-90, 80-65, 80-66, 80-90,  
85-55, 90-90, 95-55,  
100-90, 115-90, 130-90,  
140-90, F100, F110, F115,  
F120, F130, F140



**T3685**

98465322, 98497117  
- 01/93→12/95:  
45-66, 50-66, 55-46,  
55-65, 55-66, 55-90, 60-46,  
60-65, 60-66, 60-90, 65-46,  
65-66, 65-90, 70-65, 70-66,  
70-90, 80-65, 80-66, 80-90,  
85-55, 90-90, 95-55,  
100-90, 115-90, 130-90,  
140-90, "76", "86", "93",  
"94", F100, F110, F115,  
F120, F130, F140



**T3756**

8013363, 99454833  
- 01/96→:  
45-66, 50-66, 55-46,  
55-65, 55-66, 55-90, 60-46,  
60-65, 60-66, 60-90, 65-46,  
65-66, 65-90, 70-65, 70-90,  
80-65, 80-66, 80-90, 85-55,  
90-90, 95-55, 100-90,  
115-90, 130-90, 140-90,  
TN65F, TN75F, TN90F, "76",  
"86", "93", "94",  
L60, 65, 75, 85, 95 (95→),  
TL70, 80, 90, 100 (98→),  
TN55, 65, 75, 90 (98→)



**F0665**

87802496  
- TM155, 175, 190

25.07.2008



T3754



T3692



T3692A



TRACTOR MODEL	WATER PUMP REPAIR KIT	THERMOSTAT	WATER PUMP CONNECTOR	GASKET O-RING
311, 312, 315	<b>T3212</b> 589323	<b>T2041</b> 4086415		
411, 415	<b>T3056</b> 1909619	<b>T2041</b> 4086415		
450, 500, 550 600, 640		<b>T3754</b> 4569187	<b>T3691</b> 4615794	<b>T3691A</b> 4673810 <b>T3691B</b> 024600
650, 750, 850		<b>T3209</b> 8826010		
1000		<b>T3754</b> 4569187	<b>T3691</b> 4615794	<b>T3691A</b> 4673810 <b>T3691B</b> 024600
480		<b>T3754</b> 4569187	<b>T3691</b> 4615794	<b>T3691A</b> 4673810 <b>T3691B</b> 024600
580, 680, 780		<b>T3754</b> 4569187	<b>T3691</b> 4615794	<b>T3691A</b> 4673810 <b>T3691B</b> 024600
880 4-cyl.		<b>T3209</b> 8826010		
880 5-cyl., 980, 1180, 1380		<b>T3754</b> 4569187	<b>T3691</b> 4615794	<b>T3691A</b> 4673810 <b>T3691B</b> 024600
1580, 1880		<b>T3208</b> 4808727		
160-90 180-90		<b>T3208</b> 4808727		
→ 12/92: 45-66, 50-66, 55-46, 55-65, 55-66, 55-90, 60-46, 60-65, 60-66, 60-90, 65-46, 65-66, 65-90, 70-65, 70-66, 70-90, 80-65, 80-66, 80-90, 85-55, 90-90, 95-55, 110-90, 100-90, 115-90, 130-90, 140-90, F100, F110, F115, F120, F130, F140		<b>T3754</b> 4569187	<b>T3692</b> 4770247	<b>T3692A</b> 4848840 <b>T3692B</b>
01/93→12/95: 45-66, 50-66, 55-46, 55-65, 55-66, 55-90, 60-46, 60-65, 60-66, 60-90, 65-46, 65-66, 65-90, 70-65, 70-66, 70-90, 80-65, 80-66, 80-90, 85-55, 90-90, 95-55, 100-90, 110-90, 115-90, 130-90, 140-90, 76-, 86-, 93- and 94-series, F100, F110, F115, F120, F130, F140		<b>T3754</b> 4569187		
01/96→: 45-66, 50-66, 55-46, 55-65, 55-66, 55-90, 60-46, 60-65, 60-66, 60-90, 65-46, 65-66, 65-90, 70-65, 70-90, 80-65, 80-66, 80-90, 85-55, 90-90, 95-55, 100-90, 110-90, 15-90, 130-90, 140-90, TN65F, TN75F, TN90F, 76-, 86-, 93- and 94-series, L60, L65, L75, L85, L95 (95→), TL70, TL80, TL90, TL100 (98→), TN55, TN65, TN75, TN90 (98→)		<b>T3754</b> 4569187		
M100, M115, M135, M160		<b>VPE3405</b> 87800842		



06.10.2006



## T3615

4973345, 4952981,  
4952983, 4956666

- fits:

480, 500, 540, 550, 600, 640  
55-56, 55-66, 55-88, 60-56, 60-66, 60-75, 60-88,  
90-93, 60,94, 65-56, 65-66, 65-88, 65-93, 70-56,  
70-66, 70-88, 72-93

- 4-rows

- overall height 660 mm



## T3724

5143883, 4997175

- fits:

580, 680, 780, 880,  
55-90, 60-90,  
65-90, 70-90,  
80-90

- 3-rows

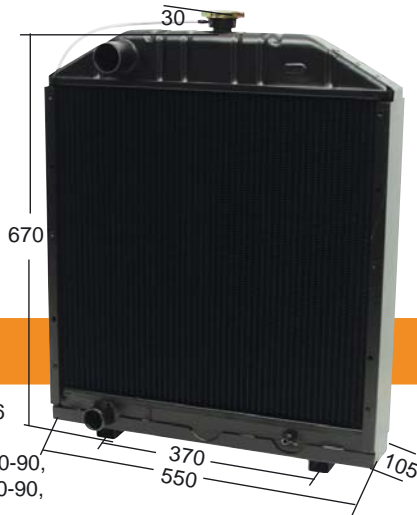

## T3725

5143884, 4997926

- fits:

780, 880, 980, 60-90,  
70-90, 80-90, 90-90,  
100-90, 110-90

- 4-rows

- overall height 700 mm



## T3757

5119698, 5123209,  
5123208, 5129229

- fits:

1580, 1880,  
130-90, 140-90,  
160-90, 180-90

- overall height 865 mm

25.07.2008



AVX10-1000



T3374



T3360



T4013

See Accessories catalog  
page T6.16c for fan belt  
reference table.

TRACTOR MODEL	FAN BELT	FAN BLADES	RADIATOR CAP	RADIATOR TOP HOSE	RADIATOR BOTTOM HOSE
450, 640	<b>AVX10-1175</b> 4796327		<b>T3360</b> 4999682	<b>T3362</b> 4950088	<b>T4013</b> 596152
750, 850	<b>AVX13-1325</b> 44010698		<b>T3360</b> 4999682		
1000	<b>T3356</b> x 2 4796327	<b>T3374</b> 4705372	<b>T3360</b> 4999682		<b>T3365</b> 597054
1300	<b>AVX13-1325</b> x 2 44010698		<b>T3360</b> 4999682		
580, 680, 780	<b>AVX10-1175</b> 4796327		<b>T3360</b> 4999682	<b>T3367</b> 4997263	<b>T4013</b> 596152
880 4-cyl.	<b>AVX10-1300</b> 4712148		<b>T3360</b> 4999682	<b>T3368</b> 4997336	
880 5-cyl., 980	<b>T3356</b> x 2 4796327	<b>T3374</b> 4705372	<b>T3360</b> 4999682	<b>T3367</b> 4997263	<b>T4013</b> 596152
1180	<b>AVX10-1175</b> x 2 4796327	<b>T3374</b> 4705372	<b>T3360</b> 4999682	<b>T3370</b> 5107001	<b>T4013</b> 596152
1380	<b>T3356</b> x 2 4796327		<b>T3360</b> 4999682	<b>T3370</b> 5107001 <b>T3371</b> 5121678	<b>T4013</b> 596152
1580, 1880	<b>AVX10-1350</b> x 2 4796442		<b>T3361</b> 5129231	<b>T3372</b> 5106829	
55-90, 60-90, 70-90, 80-90	<b>AVX10-1175</b> 4796327		<b>T3360</b> 4999682	<b>T3367</b> 4997263	<b>T4013</b> 596152
90-90	<b>AVX10-1175</b> x 2 4796327	<b>T3374</b> 4705372	<b>T3360</b> 4999682	<b>T3367</b> 4997263	<b>T4013</b> 596152
100-90	<b>AVX10-1175</b> x 2 4796327	<b>T3374</b> 4705372	<b>T3360</b> 4999682	<b>T3367</b> 4997263	<b>T4013</b> 596152
115-90	<b>AVX10-1175</b> x 2 4796327	<b>T3374</b> 4705372	<b>T3361</b> 5129231	<b>T3371</b> 5121678	<b>T4013</b> 596152
130-90, 140-90	<b>AVX10-1175</b> x 2 4796327		<b>T3361</b> 5129231	<b>T3371</b> 5121678	<b>T4013</b> 596152
160-90	<b>AVX10-1350</b> x 2 4796442		<b>T3361</b> 5129231	<b>T3372</b> 5106829	
180-90	<b>AVX10-1350</b> x 2 4796442		<b>T3361</b> 5129231	<b>T3372</b> 5106829	

25.07.2008

For tractors marked with number 1 on cylinder head



T3488

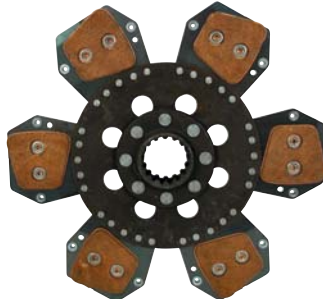

LUK331009210



LUK328009116



L6014-2RS



L6303-2RS

TRACTOR MODEL		COMPLETE CLUTCH ASSEMBLY incl. clutch plate	CLUTCH PLATE	P.T.O. CLUTCH PLATE	CLUTCH PRESSURE PLATE	RELEASE BEARING	P.T.O. BEARING	PILOT BEARING
312, 315, 411, 415	9"		T3737 4968740					
450, 480	10"		T3721 4968734					
550, 600, 640, 580, 680, 780	11"	(k)	T3022 (l) 5150650, 4999812 organic	LUK328009116 5160411		T3015 5122028	L6014-2RS 24905360	L6303-2RS 28043280
880 4-syl.	11"	(k)				T3015 5122028	L6014-2RS 24905360	L6303-2RS 28043280
55-90, 60-90 65-90, 70-90	11"	T3487(c) 805656 organic	T3022 (l) 5150650, 4999812 T3495 (m) 5145708	LUK328009116 (h) 5160411 LUK328018616 5154703	T3505	LUK500045900 5122028	L6014-2RS 24905360	L6303-2RS 28043280
70-90, 80-90 85-90	11"	T3488(c) 5150646 ceramic	T3496 5150647	LUK328009116 (h) 5160411 LUK328018616 5154703	T3505	LUK500045900 5122028	L6014-2RS 24905360	L6303-2RS 28043280
850, 1000	12"		T3494 5160410					L6304-2RS(f) 410001710 L6204-2RS(g) 5120853
880 4-cyl.	12"	(k)					L6014-2RS 24905360	L6304-2RS 410001710
880 5-cyl., 980, 90-90, 100-90, 110-90	12"	(k)	T3492 5150922 ceramic or T3059A 5112856 organic				L6014-2RS 24905360	L6204-2RS 5120853
90-90 100-90 110-90	12"	T3665 (e) 5144020	LUK331009210 5144740	LUK331013216 5154514		LUK500045900 5122028	L6015-2RS 5112084	L6204-2RS 5120853
1180 115-90	12"	(k)		LUK331013016 5154551		LUK500005910 5120853	LUK500005810 44016827	L6204-2RS 5120853

b - 2/80 → complete

c - When assembling new T3487 or T3488 assembly, P.T.O. plate LUK328018616 (7,6 mm) must definitely be used. Can be replaced with LUK clutches on the next page (LUK228007714 and LUK228007710).

d - toggle lever finger set

e - when assembling new T3665 assembly, P.T.O. plate LUK331013216 (7,6 mm) must definitely be used. Can be replaced with LUK clutch LUK231004911.

f - 850

g - 1000

h - LUK328009116 thickness 8,6 mm, LUK328018616 thickness 7,6 mm, LUK331013216 thickness 7,6 mm

k - see page C1.20

l - fixed

m - springed

08.05.2009

For tractors marked with number 2 or 3 on cylinder head



LUK228007714



T3022



LUK331009516



T3020



LUK500005910



LUK500039300



L6303-2RS

TRACTOR MODEL	COMPLETE CLUTCH ASSEMBLY includes clutch plate	CLUTCH PLATE	P.T.O. CLUTCH PLATE	TOGGLE LEVER FINGER SET (c)	RELEASE BEARING	P.T.O. BEARING	PILOT BEARING
(k): 550, 600, 640, 580, 680, 780	LUK228007714(a,d,1) 5106755 LUK228007710(b,d,1) 5145717	T3022 (a) 5150650 LUK328018510 (b) 5145718	LUK328009116 (f) 5160411 LUK328018616	T3020 9962518	LUK500045900	L6014-2RS	L6303-2RS
55-90, 60-90, 70-90, 80-90, 65-90, 85-90	11" LUK228007714(a,d,1) 5106755 LUK228007710(b,d,1) 5145717	T3022 (a) 5150650 LUK328018510 (b) 5145718	LUK328009116 (f) 5160411 LUK328018616	T3020 9962518	LUK500045900	L6014-2RS	L6303-2RS
650, 750	12"	T3474 (i) 9004183	LUK331009516 (h) 9004189		LUK500045900	L6014-2RS	L6304-2RS
850, 880	4 cyl. 11"	LUK228003110(1) 5107183	LUK328007410 5102262	LUK328009216 5160410	T3020 9962518	LUK500045900	L6014-2RS L6304-2RS
880 4 cyl., 880 5cyl., 980, 90-90, 100-90, 110-90 90-95	12"	LUK231004911(e,1,p) 5154514 LUK231004919 (q) 5163936	LUK331009210(b) 5144740 LUK331013119 5163937 (7-blade spring) T3059A (a)	LUK331013216 5156514	LUK500045900	L6015-2RS 5112084	L6304-2RS (880-4) L6204-2RS
1000	13"						L6204-2RS
1180, 115-90	12"	LUK231005010 (1) 5144661		LUK331009516 9004189	LUK500005910 5120853	LUK500005810 44016827	L6204-2RS
1580, 1880, 160-90, 180-90	12"	LUK631026109(1, 2) 5140361	LUK331010310 5118453		LUK500005910 5120853		
L60		LUK628191009 (m, 1)					
L65		LUK231008910 (1) 5167933	LUK330005110 5167928		LUK500045900	LUK500039300	LUK410002500
L75, L85 TL80, TL90		LUK231008810 (1) 5167936	LUK331021910 5167936		LUK500045900	LUK500039300 5167183	LUK410002500 28043280

a - organic  
b - ceramic

c - set for one clutch

d - When assembling new **LUK228007714** or **LUK228007710** assembly, P.T.O. plate **LUK328018616** (7,6 mm) must definitely be used. Can be replaced with clutches **LUK328009216**, **T3487** and **T3488** on previous page.

e - When assembling new **LUK231004911** assembly, P.T.O. plate **LUK331013216** (7,6 mm) must definitely be used. Can be replaced with Valeo **T3665** on previous page.

f - thickness **LUK328009116** = 8,6 mm **LUK328018616** = 7,6 mm

g - thickness **LUK331013216** = 7,6 mm

h - 11 splines, diameter 32mm

i - 18 splines, diameter 50mm

k - these models appear with two different kind of clutch shaft. Check suitability before fitting!

m - including assembly and drive plate

p - includes drive plate C-6

q - includes drive plate C-7

1 - drive clutch plate

2 - P.T.O clutch plate





# FIAT, FIATAGRI FERODO VALEO

Early FERODO-clutches replacement with new VALEO 6-fingers clutches



25.07.2008



TRACTOR MODEL		ASSEMBLY includes drive clutch plate	CLUTCH PLATE DRIVE gear box side	CLUTCH PLATE P.T.O. flywheel side	COMPL. CLUTCH SET incl. assy, drive- and P.T.O. clutches and release bearing(e)	RELEASE BEARING COMPL.	PILOT BEARING
550, 600, 640, 580, 680, 780	280 mm	<b>M600</b> 5177193 <b>(T3480)</b> (f) 5150650	<b>D537C</b> (c) 5150653 <b>T3022</b> (d) 5150650	<b>LUK328018616</b> 5152710	<b>K200E</b> (g) 1930987	<b>R242</b> 5177194	<b>L6303-2RS</b> 28043280
850, 1000	310 mm	<b>(T3485)</b> (f) 5177203	<b>T3494</b> 44015757		<b>K204E</b> (h) 1930990	<b>R246</b> 5177204	<b>L6304-2RS</b> (a) 410001710 <b>L6204-2RS</b> (b) 5120853
880, 880/5, 980, 90-90, 100-90, 110-90	310 mm	<b>M602</b> 5177196 <b>(T3483)</b> (f)	<b>T3492</b> 5150922	<b>LUK331013216</b> 5152736	<b>K202E</b> (h) 1930988		<b>L6204-2RS</b> 5120853
1180, 115-90	310 mm	<b>M603</b> 5177199 <b>(T3484)</b> (f)	<b>D538C</b> 5151000	<b>LUK331013016</b> 5151001		<b>R245</b> 1930989	<b>L6204-2RS</b> 5120853

a - 850

b - 1000

c - ceramig

d - organic

e - the set includes assembly, clutch plates and complete release bearing

f - old order number

g - when assembling, 6 pcs of bolts is needed, order number **PKH10090125**

h - when assembling, 6 pcs of bolts is needed, order number **PKH10100125**

When replacing early type clutch, new complete release set and P.T.O. clutch plate must be changed. In this case we recommend complete clutch set.

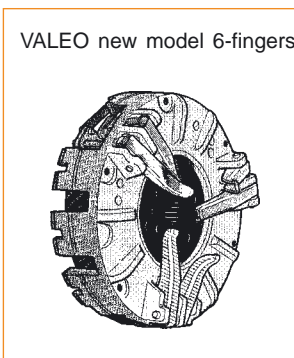
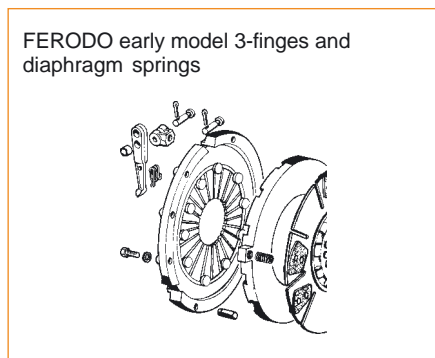

**HUB GREASE**

**LUK414001410**  
- especially for clutch centres and shafts

C1.20

08.05.2009



LUK135021510

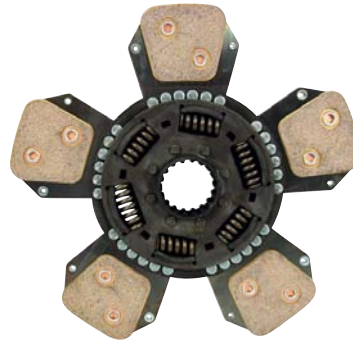

LUK333007211

TRACTOR MODEL		COVER ASSY	CLUTCH PLATE	RELEASE BEARING
1180, 1380, 1580, 1880	14"	<b>LUK135020510</b> (3) 5123061	<b>LUK335012910</b> 5150080 <b>T3472</b> 5118453	<b>T3465</b> 5121414
115-90, 130-90, 140-90	14"	<b>LUK135020510</b> (3) 5123061	<b>LUK335012910</b> 5150080 <b>T3472</b> 5118453	<b>T3465</b> 5121414
Winner F100, F110, F115, F120 New Holland M100, M115	330 mm	<b>LUK133021410</b> (3) 5154418	<b>LUK333007211</b> 5165650	<b>T3684</b> 5149611
Winner F130, F140 New Holland M135	350 mm	<b>LUK135021510</b> (3) 88203039	<b>LUK335012910</b> 5150080	<b>T3684</b> 5149611
L85, L95 New Holland M135, TL90	310 mm	<b>LUK131024910</b> (3) 5167939, 5189823	<b>LUK331021910</b> 5167939	

3 - no plate

## SPRING CLUTCH SLEEVE

### FT44011615

44011615

- 100-90, 110-90, 115-90, 130-90, 140-90, 160-90, 180-90, 55-90, 60-90, 65-90, 70-90, 80-90, 85-90, 90-90,  
L60, L65, L75, L85, L95, TL60, TL65, TL70, TL80, TL90, TL100

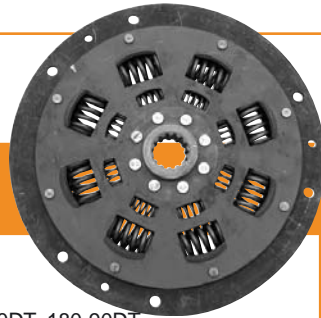

### BALANCE WHEEL DAMPER

#### LUK370001110

5153359

- 130-90DT, 140-90DT, 160-90DT, 180-90DT  
- Power Shift -gearing

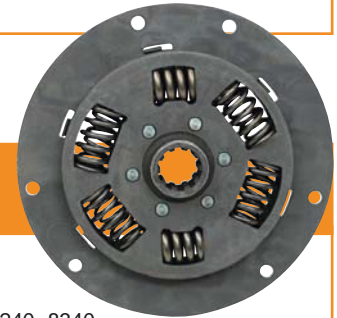

### BALANCE WHEEL DAMPER

#### LUK370000910

82008857

- 5640, 6640, 7740, 7840, 8240, 8340,  
TS90, TS100, TS110 TS115  
- Power Shift -gearing



### BALANCE WHEEL DAMPER

#### LUK370001010

5187845

- 8160, 8260, 8360, 8560, M100, M115, M135, M160,  
TM115, TM125, TM135, TM150, TM165  
- Power Shift -gearing



### BALANCE WHEEL DAMPER

#### LUK370001710

5187958

- TL70, TL80, TL90, TL100  
- Power Shift -gearing



25.07.2008

450  
480  
500  
550  
580  
600  
640  
680  
780

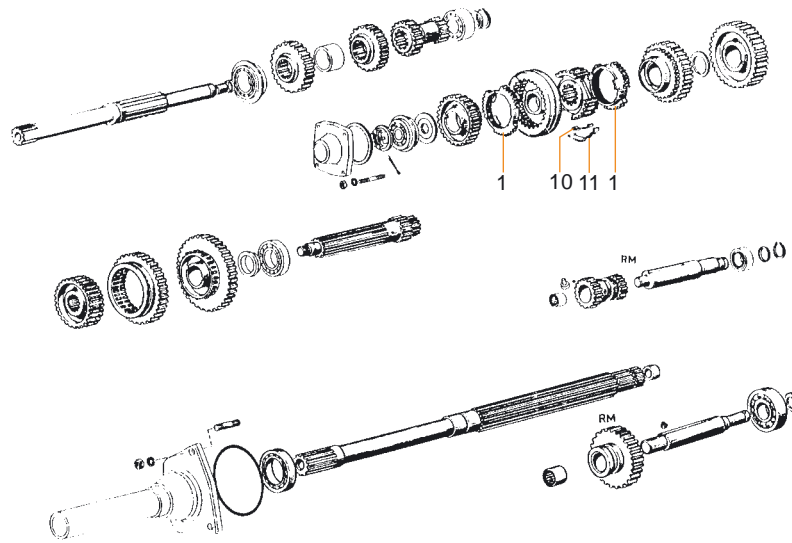

450  
480  
580  
640  
680  
780  
880  
980  
1180  
1380  
1580

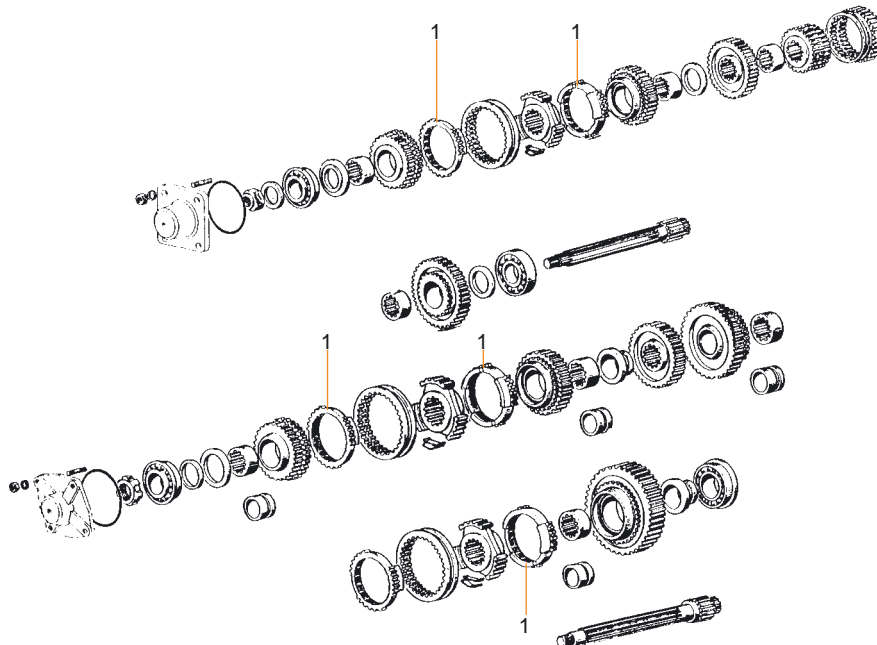

PART	315	450	480	500	580	780	880	980	1180
	415	640	600	550	680			1580	1380
<b>1. Synchronizer</b>	<b>T3007</b> 5118187	<b>T3007</b> 5118187	<b>T3007</b> 5118187	<b>T3007</b> 5118187	<b>T3007</b> 5118187	<b>T3007</b> 5118187	<b>T3007</b> 5118187	<b>T3007</b> 5118187	<b>T3007</b> 5118187
<b>10. Coupling</b>		<b>T3011</b> 4568626	<b>T3011</b> 4568626	<b>T3011</b> 4568626			<b>T3011</b> 4568626	<b>T3011</b> 4568626	
<b>11. Spring</b>		<b>T3012</b> 4572860	<b>T3012</b> 4572860	<b>T3012</b> 4572860			<b>T3012</b> 4572860	<b>T3012</b> 4572860	
<b>CLUTCH SHAFT AND GEAR BOX OIL SEALS</b>	780 580 680	600 640	880 4-syl. 880 5-syl. 980, 90-90, 100-90	55-90 60-90 70-90 80-90	115-90 130-90	650	1180, 1380, 1580, 1880, 140-90 160-90 180-90		
<b>Clutch shaft seal</b>	<b>OAS456210</b> 40000270 BIRD	<b>OAS456510</b> 40000370	<b>OAS50689</b> 5106069	<b>OAS458510</b> 5123299	<b>OAS557010</b> 5112307	<b>OAS557510</b> 44014376	<b>OAS557010</b> 5112307		
<b>Gear box rear main seal</b>	<b>OAS25357</b> 5105887		<b>OAS28387</b> 5106073		<b>OAS32427</b> 5112294				

08.05.2009

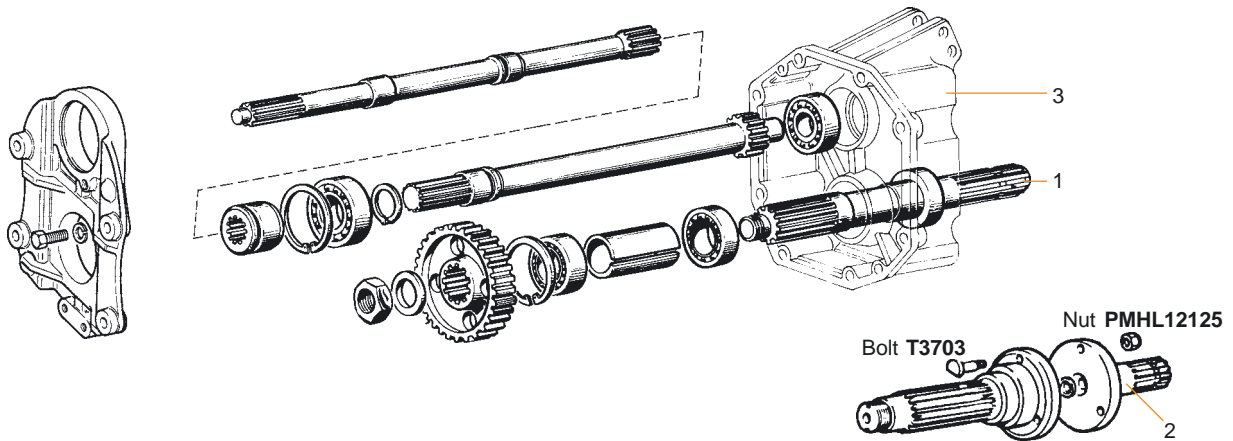

TRACTOR MODEL	1. P.T.O. SHAFT 1-speed	2. P.T.O. SHAFT with 2-speeds flange		3. REAR HOUSING 2-speeds
		540 1/min 1 3/8 6Z	540 1/min 1 3/4 6Z	
750	<b>T3074</b> 44017106	<b>T3074</b> 44017106	<b>T3075</b> 5158578	
1000		<b>T3074</b> 44017106	<b>T3075</b> 5158578	
850, 1000 Super		<b>T3074</b> 44017106	<b>T3075</b> 5158578	
1300, 1300 Super		<b>T3074</b> 44017106	<b>T3075</b> 5158578	
580, 680, 780	<b>T3030</b> 4998230	<b>T3074</b> 44017106	<b>T3075</b> 5158578	<b>T3612</b> 5143642
880 4 cyl., 880 5 cyl.		<b>T3074</b> 44017106	<b>T3075</b> 5158578	<b>T3612</b> 5143642
980		<b>T3074</b> 44017106	<b>T3075</b> 5158578	<b>T3612</b> 5143642
1180, 1380, 1580, 1880		<b>T3074</b> 44017106	<b>T3075</b> 5158578	
60-90, 70-90, 80-90		<b>T3074</b> 44017106	<b>T3075</b> 5158578	
110-90, 90-90, 100-90		<b>T3074</b> 44017106	<b>T3075</b> 5158578	<b>T3612</b> 5143642
115-90, 130-90, 140-90, 160-90, 180-90		<b>T3074</b> 44017106	<b>T3075</b> 5158578	
F100, F110, F115, F120, L60, L65, L75, L85, L95, M100, M115, M135, M160, TL65, TL70, TL80, TL90, TM110, TM120, TM130, TM140			<b>T3075</b> 5158578	

## TRANSVERSE GEAR

**FT4984103**  
4984103  
- 880-110-90  
- drive P.T.O.

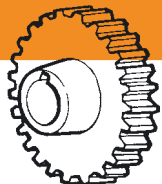

## P.T.O. GEAR

**FT4995695**  
4995695  
- 880-110-90  
- to pinion shaft







# FIAT, FIATAGRI HYDRAULIC POWER CLUTCH



T3096



T3528



T3529



OAS508010

TRACTOR MODEL	HYDRAULIC P.T.O. CLUTCH	CLUTCH PLATE SET	CLUTCH HYDRAULIC PUMP	P.T.O. SEAL
1180	<b>T3096</b> 5107939	<b>T3528</b> 9968954	<b>T3529</b> 5135305	
1380	<b>T3096</b> 5107939	<b>T3528</b> 9968954	<b>T3529</b> 5135305	
1580	<b>T3096</b> 5107939	<b>T3528</b> 9968954	<b>T3529</b> 5135305	
1880	<b>T3096</b> 5107939	<b>T3528</b> 9968954	<b>T3529</b> 5135305	
115-90	<b>T3096</b> 5107939	<b>T3528</b> 9968954	<b>T3529</b> 5135305	
130-90	<b>T3096</b> 5107939	<b>T3528</b> 9968954	<b>T3529</b> 5135305	
140-90	<b>T3096</b> 5107939	<b>T3528</b> 9968954	<b>T3529</b> 5135305	
160-90	<b>T3096</b> 5107939	<b>T3528</b> 9968954	<b>T3529</b> 5135305	
180-90	<b>T3096</b> 5107939	<b>T3528</b> 9968954	<b>T3529</b> 5135305	
680, 780, 880 4-cyl., 880 5-cyl., 90-90 1-speed				<b>OAS558510</b> 5105899
580, 680, 780, 880 4-cyl., 880 5-cyl., 980, 80-90, 100-90, 115-90, 130-90, 2-speeds				<b>OAS689010</b> 515891
60-90, 70-90, 80-90, 640 1-speed				<b>OAS508010</b> 5111518
55-90, 60-90, 70-90 2-speeds				<b>OAS558010</b> 5119203
1180, 1380, 1580, 1880, 140-90, 160-90, 180-90 2-speeds				<b>OAS689010</b> 5112290

06.10.2006

**COMPLETE  
DIFFERENTIAL GEARS**

T3591

**T3591**

5117236

- fits: 580, 680 later model, 780,  
70-90, 80-90, L75, L85, L95, TL80, TL90

**T3335**

5117247

- fits: 880 4-cyl., 880 5-cyl., 980, 90-90, 100-90, 110-90



25.07.2008



FT5131916



T3550



T3553

TRACTOR MODEL	REAR AXLE	REAR MAIN OIL SEAL	REAR WHEEL BOLT	REAR WHEEL NUT
312, 315, 411, 415, 450, 500, 550, 600, 640, 650, 750		OAS50689 7106795	T3549	
850, 1000, 1000 Super			T3550 44011089	T3553 (e) 12164211
580		FT5123205 5123205	T3550 44011089	T3553 (e) 12164211
680	T3034 5168626	FT5123205 5123205	T3550 44011089	T3553 (e) 12164211
780	T3034 5168626	FT5123205 5123205	T3550 44011089	T3553 (e) 12164211
880-4		FT5123253 5123253	T3550 44011089	T3553 (e) 12164211
880-5		FT5123253 5123253	T3550 44011089	T3553 (e) 12164211
980	T3534 5123257	FT5123259 5123259	T3550 44011089	T3553 (e) 12164211
1180, 1380, 1580	T3535 (a) 5135352		T3552 5102745	T3553 (e) 12164211
55-90, 60-90, 65-90	T3536 5131917	FT5131916 5131916	T3550 44011089	T3553 (e) 12164211
70-90, 80-90	T3034 5168626	FT5123205 5123205	T3550 44011089	T3553 (e) 12164211
90-90		FT5123253 5123253	T3550 44011089	T3553 (e) 12164211
100-90, 110-90	T3534 5123257	FT5123259 5123259	T3550 44011089	T3553 (e) 12164211
115-90			T3552 5102745	T3553 (e) 12164211
130-90, 140-90, 160-90	T3535 (a) 5135352	FT5126465 5126465	T3552 5102745	T3553 (e) 12164211

a - partly see the dimensions on old shaft

	inner bearing ins. dim.	outer bearing ins. dim.	oil seal inside dimension
 T3535	80	90	130 mm

e - washer for nut T3554

## PRESS RIM NUT

**FT5100941**

5100941

- for Fiat -tractors with press rim center plates



08.05.2009



T3421



T3071



T3070



T3743

TRACTOR MODEL	BRAKE DISC	HAND BRAKE PAD 1-SIDES	HAND BRAKE PAD 2-SIDES	PISTON O-RINGS
640	<b>T3178</b> (a) 5107958			
580, 680, 780	<b>T3423</b> (c) 5112630	<b>T3071</b> 5158120	<b>T3070</b> 5158123	<b>T3745</b> (d) 5105536 <b>T3744</b> (e) 5105534
880 4-cyl., 880 5-cyl., 980	<b>T3423</b> (c) 5112630	<b>T3071</b> 5158120	<b>T3070</b> 5158123	<b>T3742</b> (d) 5169562 <b>T3743</b> (e) 5169561
1180, 1380, 1580, 1880		<b>T3071</b> 5158120	<b>T3070</b> 5158123	
55-90, 60-90, 70-90, 80-90	<b>T3421</b> 4997208 5184313			<b>T3745</b> (d) 5105536 <b>T3744</b> (e) 5105534
90-90, 100-90	<b>T3423</b> 5112630	<b>T3071</b> 5158120	<b>T3070</b> 5158123	<b>T3742</b> (d) 5169562 <b>T3743</b> (e) 5169561
115-90, 130-90, 140-90, 160-90, 180-90		<b>T3071</b> 5158120	<b>T3070</b> 5158123	
570, 580, 60-93, 60-94, 65-90, 65-93, 65-94, 670, 680, 72-93, 72-94, 780, 82-93, 82-94, 85-90, 88-93, 88-94, L60, L65, L75, L85, L95	<b>T3421</b> 4997208 5184313			

a - brake band

d - big

e - small



## BRAKE STUD VALVE AND SPRING

- 80, 90 and 94-series

**T3746**  
4997674

**T3747**  
4999488





## LEVELLING BOX

### T3655

4999165  
- Fiat 640  
(upper picture)

### T3739

5125920  
- 70-90, 80-90  
- adjustment 640-760 mm  
- for 24 mm lower link



## STABILIZER SUPPORT

### T0422

5127401  
- 4-cyl. 80, -90, -94-series  
- L = 1150 mm

### T0408

5127015  
- 6-cyl. 80, -90-series  
up to 110-90  
- L = 1550

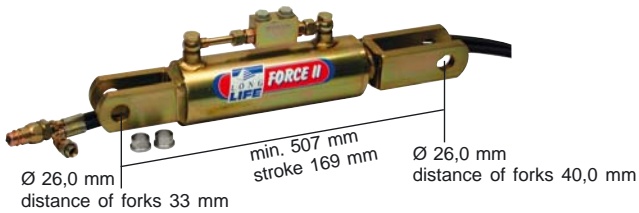

## HYDRAULIC LEVELLING BOX

### T1720

- 60-90-110-90  
- piston 80 mm  
- shaft 40 mm  
- adapter sleeve 25,9/22,2 mm 2 pcs

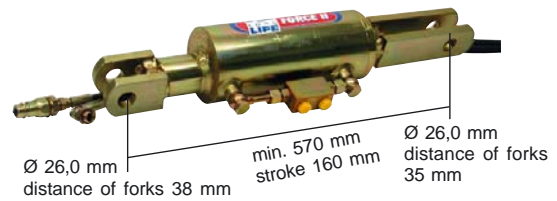

## HYDRAULIC LEVELLING BOX

### T1722

- New Holland M135  
- piston 100 mm  
- shaft 50 mm



## STABILIZER PAIR

### T0171

- Fiat 415, 600, 640  
- inner pin 30x30 mm  
- pin 12 mm

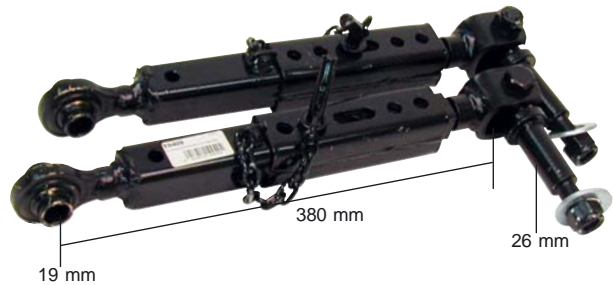

## STABILIZER PAIR

### T0409

5123273  
- Fiat 580, 680, 780  
- inner pipe 30x30 mm, pin 12 mm

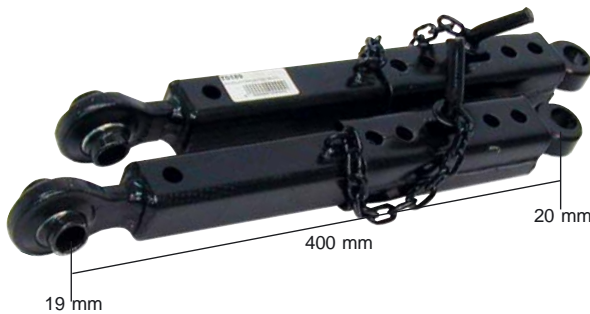

## STABILIZER PAIR

### T0189

5123273  
- Fiat 55-90-110-90  
- inner pipe 30x30 mm, pin 12 mm

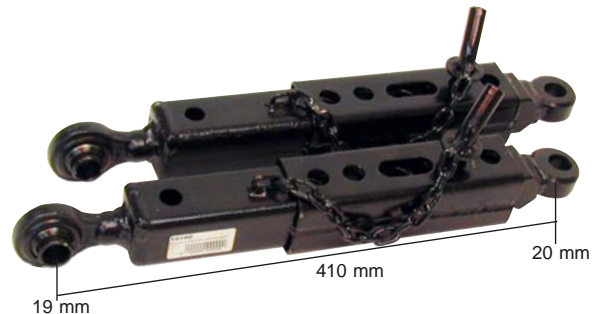

## STABILIZER PAIR

### T0190

5109518  
- Fiat Winner-series  
- inner pipe 40x40 mm, pin 16 mm

06.10.2006



T3738



T3083



T3048



T3748



T3750



T3677

TRACTOR MODEL	HYDR. LIFT SHAFT	HYDR. LIFT SHAFT BUSH	HYDR. LIFT SHAFT GASKET	LOWER LINK SHAFT	LOWER LINK SEAL
312, 315, 411, 415, 450, 500, 550, 600, 640	<b>T3048</b> 4955425				
580, 680, 780, 80 4-cyl.			<b>T3750</b> 5159078		
580, 680, 780, 880 4-cyl., 880 5-cyl., 980 later model			<b>T3750</b> 5159078	<b>T3548</b> 5111458	
55-90, 60-90, 70-90, 80-90, 65-90		<b>T3748</b> (a) 5186406 <b>T3749</b> (b) 5186405	<b>T3750</b> 5159078	<b>T3083</b> 5116243	<b>T3677</b> 5121123
1180, 1380, 1580, 1880, 115-90, 130-90, 140-90, 160-90, 180-90		<b>T3748</b> (a) 5186406 <b>T3749</b> (b) 5186405	<b>T3750</b> 5159078		
90-90, 100-90		<b>T3748</b> (a) 5186406 <b>T3749</b> (b) 5186405	<b>T3750</b> 5159078	<b>T3548</b> 5111458	

a - right 2 pcs/tractor

b - left 2 pcs/tractor

## STABILIZER PIN



### T0616

5103862  
- thickness 16 mm  
- length 62 mm

### T0619

5105520  
- thickness 19 mm  
- length 73 mm

## LIFT CYLINDER SEALS



T3731



T3732



T3735



T3736

TRACTOR MODEL	SUPPORT RING	O-RING FRONT	O-RING REAR	SUPPORT RING REAR
640, 550, 580, 680, 780, 880, 980	<b>T3729</b> 4999412	<b>T3732</b> 14472880	<b>T3735</b> 14472380	<b>T3736</b> 5106297
55-90, 60-90, 65-90		<b>T3733</b> 1446568		
70-90, 80-90, 85-90, 90-90, 100-90, 110-90	<b>T3731</b> 5125941	<b>T3734</b> 14465981		

25.07.2008



T3452

T3112

T3446, T3448, T3448XL

T3713

TRACTOR MODELS	HYDRAULIC PUMP		POWER STEERING PUMP	HYDR. DRIVE GEAR	CONNECTING BUSH	COUPLING
450	<b>T3452</b> 8273385		<b>T3111</b> 50130133	<b>T3049</b> 4673811	<b>T3089</b> 5118570	<b>T3088</b> 5118569
600, 640	<b>T3112</b> 5129478	<b>T3446 (a)</b> 5129483	<b>T3111</b> 50130133	<b>T3049</b> 4673811	<b>T3089</b> 5118570	<b>T3088</b> 5118569
750	<b>T3112</b> 5129478		<b>T3111</b> 50130133			
850, 1000	<b>T3446</b> 5129483		<b>T3111</b> 50130133	<b>T3443</b> 4747597	<b>T3089</b> 5118570	<b>T3088</b> 5118569
1000, 1300			<b>T3111</b> 50130133	<b>T3443</b> 4747597	<b>T3089</b> 5118570	<b>T3088</b> 5118569
580, 680, 780	<b>T3112</b> 5129478	<b>T3446 (a)</b> 5129483	<b>T3111</b> 50130133	<b>T3049</b> 4673811	<b>T3089</b> 5118570	<b>T3088</b> 5118569
880 4-cyl.	<b>T3112</b> 5129478	<b>T3446 (a)</b> 5129483	<b>T3111</b> 50130133		<b>T3089</b> 5118570	<b>T3088</b> 5118569
880 5-cyl.	<b>T3112</b> 5129478	<b>T3446 (a)</b> 5129483	<b>T3452</b> 8273385 <b>T3453 (b)</b> 98307212	<b>T3443</b> 4747597	<b>T3089</b> 5118570	<b>T3088</b> 5118569
980	<b>T3112</b> 5129478	<b>T3446 (a)</b> 5129483	<b>T3453 (b)</b> 98307212	<b>T3443</b> 4747597	<b>T3089</b> 5118570	<b>T3088</b> 5118569
1180	<b>T3446</b> 5129483		<b>T3453 (b)</b> 98307212	<b>T3443</b> 4747597	<b>T3089</b> 5118570	<b>T3088</b> 5118569
1380	<b>T3448</b> 5129488		<b>T3453 (b)</b> 98307212	<b>T3443</b> 4747597	<b>T3089</b> 5118570	<b>T3088</b> 5118569
1580, 1880	<b>T3448</b> 5129488		<b>T3453 (b)</b> 98307212		<b>T3089</b> 5118570	<b>T3088</b> 5118569
55-90, 60-90, 70-90, 80-90	<b>T3446</b> 5129483	<b>T3448 (a)</b> 5129488	<b>T3454 (b)</b> 5180269 tai <b>T3455 (c, b)</b> 5180273		<b>T3089</b> 5118570	<b>T3088</b> 5118569
90-90, 100-90, 110-90	<b>T3448</b> 5129488	<b>T3448XL (a)</b> 2TK22S	<b>T3454</b> 5180269 tai <b>T3455 (c, b)</b> 5180273		<b>T3089</b> 5118570	<b>T3088</b> 5118569
115-90, 130-90, 140-90	<b>T3448</b> 5129488	<b>T3448XL (a)</b> 2TK22S	<b>T3455 (b)</b> 5180273		<b>T3089</b> 5118570	<b>T3088</b> 5118569
160-90, 180-90	<b>T3448</b> 5129488	<b>T3448XL (a)</b> 2TK22S	<b>T3455 (b)</b> 5180273		<b>T3089</b> 5118570	<b>T3088</b> 5118569
F110, F120	<b>T3713 (d)</b> 5179726		<b>T3714 (e)</b> 5180275			
F130, F140	<b>T3713 (d)</b> 5179726		<b>T3714 (e)</b> 5180275			

- a - larger type
- b - pump equipped with release valve
- c - in later Hi-Lo-models **T3455 (C30XRP)**
- d - **T3713 C42**
- e - **T3714 A31XRP2**

25.07.2008

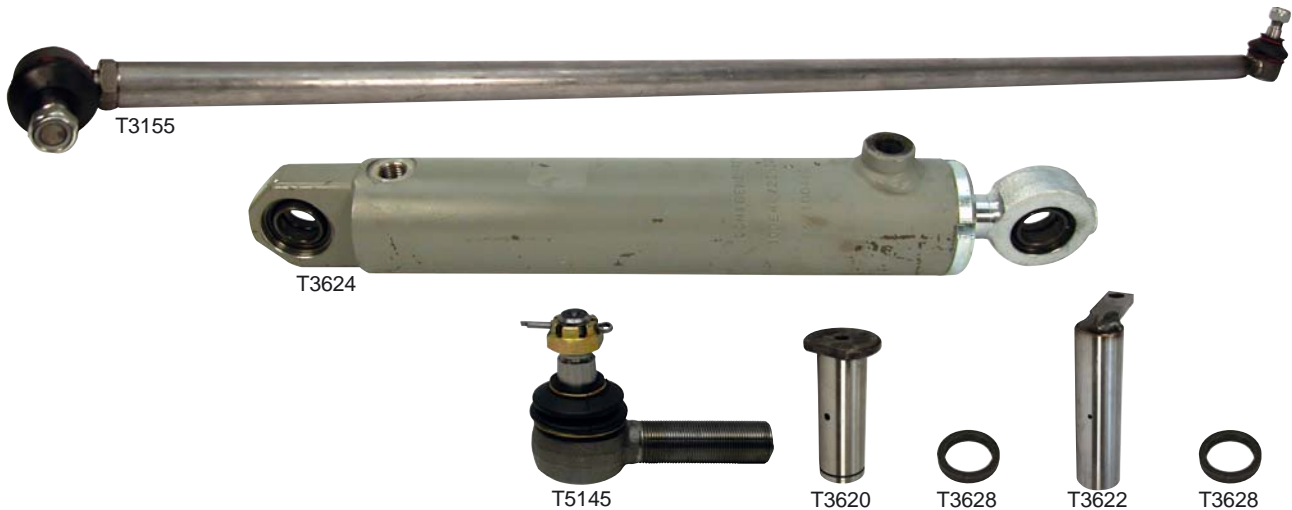

TRACTOR MODEL	COMPLETE DRAG LINK	STEERING JOINT (c)	STEERING CYLINDER	OUTER PIN	WASHER	INNER PIN	WASHER
450, 500, 600, 640, 650, 750		<b>T3154</b> 802337					
850, 1000, 1300		<b>T3559</b> 802696					
580, 680, 780	<b>T3561</b> (b) 5108800	<b>T3154</b> 802337	<b>T3624</b> 5110840	<b>T3621</b> (e) 4987671	<b>T3627</b> 5100730	<b>T3623</b> (e) 5142048	<b>T3629</b> 5100731
880 4-cyl., 880 5-cyl., 980		<b>T3559</b> 802696	<b>T3624</b> 5110840	<b>T3621</b> (e) 4987671	<b>T3627</b> 5100730	<b>T3623</b> (e) 5142048	<b>T3629</b> 5100731
1180, 1380, 1580, 1880		<b>T5145</b> 802690 <b>T3559</b> (d) 802696		<b>T3620</b> (f) 5111572	<b>T3628</b> 5111573	<b>T3622</b> (f) 5111574	<b>T3628</b> 5111573
55-90, 60-90, 65-90	<b>T3155</b> 5104081	<b>T3154</b> 802337	<b>T3624</b> 5110840	<b>T3621</b> (e) 4987671	<b>T3627</b> 5100730	<b>T3623</b> (e) 5142048	<b>T3629</b> 5100731
70-90, 80-90		<b>T5145</b> 802690 <b>T3154</b> (d) 802337	<b>T3625</b> 5137121	<b>T3620</b> (f) 5111572	<b>T3628</b> 5111573	<b>T3622</b> (f) 5111574	<b>T3628</b> 5111573
90-90, 100-90, 110-90		<b>T5145</b> 802690 <b>T3154</b> (d) 802337	<b>T3625</b> 5137121	<b>T3620</b> (f) 5111572 <b>T3621</b> (d) 4987671	<b>T3628</b> 5111573 <b>T3627</b> (d) 5100730	<b>T3622</b> (f) 5111574 <b>T3623</b> (d) 5142048	<b>T3628</b> 5111573 <b>T3629</b> (d) 5100731
115-90, 130-90, 140-90, 160-90, 180-90		<b>T5145</b> 802690		<b>T3620</b> (f) 5111572 <b>T3621</b> (d) 4987671	<b>T3628</b> 5111573 <b>T3627</b> (d) 5100730	<b>T3622</b> (f) 5111574 <b>T3623</b> (d) 5142048	<b>T3628</b> 5111573 <b>T3629</b> (d) 5100731

a - length 1375 mm

b - length 1380 mm

c - **T3154** thread 19,8 mm, cone 18,2/19,5

**T3559** thread 24 mm, cone 18,2/20,5

**T5145** thread 23,8 mm, cone 20/22

d - if front axel is originally equipped with two steering cylinders

e - bearing **GE20**, Ø 20 mm

f - bearing **GE25**, Ø 25 mm

25.07.2008

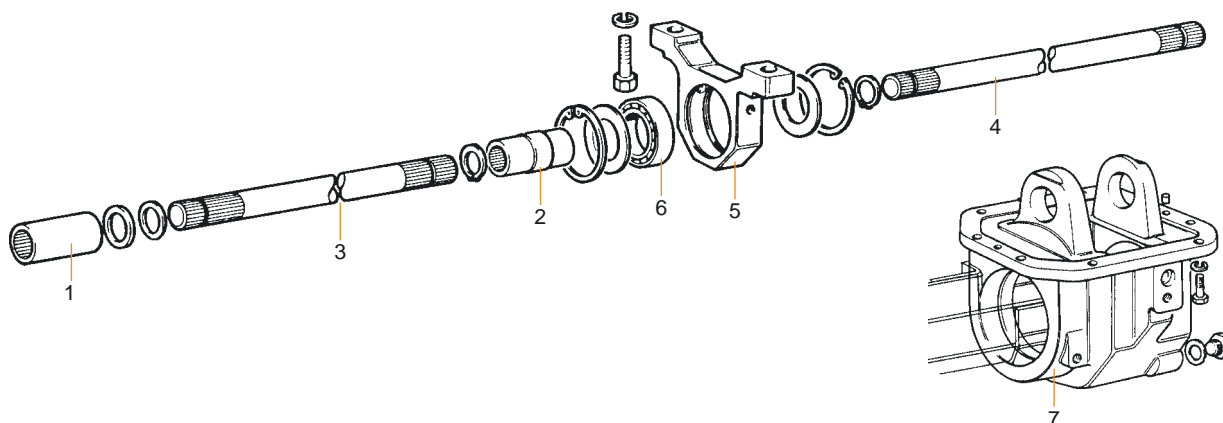

TRACTOR MODEL	1 CARDAN COUPLING FRONT	2 CARDAN COUPLING MIDDLE	3 CARDAN SHAFT FRONT	4 CARDAN SHAFT REAR	5 CARDAN SUPPORT	6 SUPPORT BEARING	7 FWD HOUSING TO GEARBOX
<b>580</b>	<b>T3120</b> 5199243	<b>T3118</b> 4997312			<b>T3068</b> 4997310	<b>L6008-2RS</b> 24905120	
<b>680, 780</b>	<b>T3120</b> 5199243	<b>T3118</b> 4997312	<b>T3119 (a)</b> 5108753		<b>T3068</b> 4997310	<b>L6008-2RS</b> 24905120	
<b>880 4-cyl., 880 5-cyl.</b>	<b>T3323</b> 4994076	<b>T3324</b> 4994075			<b>T3069</b> 4994065	<b>L6009-2RS</b> 24905130	
<b>980</b>	<b>T3323</b> 4994076	<b>T3324</b> 4994075			<b>T3069</b> 4994065	<b>L6009-2RS</b> 24905130	
<b>1180, 1380</b>	<b>T3323</b> 4994076	<b>T3324</b> 4994075			<b>T3069</b> 4994065	<b>L6009-2RS</b> 24905130	
<b>1580, 1880</b>	<b>T3323</b> 4994076	<b>T3324</b> 4994075			<b>T3069</b> 4994065	<b>L6009-2RS</b> 24905130	
<b>55-90, 60-90, 65-90</b>	<b>T3120</b> 5199243	<b>T3118</b> 4997312		<b>T3391</b> 5121352	<b>T3068</b> 4997310	<b>L6008-2RS</b> 24905120	<b>T3639</b> 5169906
<b>70-90, 80-90</b>	<b>T3120</b> 5199243	<b>T3118</b> 4997312	<b>T3392</b> 5121364	<b>T3391</b> 5121352	<b>T3068</b> 4997310	<b>L6008-2RS</b> 24905120	<b>T3639</b> 5169906
<b>90-90</b>	<b>T3323</b> 4994076	<b>T3324</b> 4994075			<b>T3069</b> 4994065	<b>L6009-2RS</b> 24905130	
<b>100-90, 110-90</b>	<b>T3323</b> 4994076	<b>T3324</b> 4994075			<b>T3069</b> 4994065	<b>L6009-2RS</b> 24905130	
<b>90-90, 100-90, 110-90 (quick type)</b>	<b>T3323A</b> (14 splines) 5150124				<b>T3069</b> 4994065	<b>L6009-2RS</b> 24905130	
<b>115-90, 130-90, 140-90</b>	<b>T3323</b> 4994076	<b>T3324</b> 4994075			<b>T3069</b> 4994065	<b>L6009-2RS</b> 24905130	
<b>160-90, 180-90</b>	<b>T3323</b> 4994076	<b>T3324</b> 4994075			<b>T3069</b> 4994065	<b>L6009-2RS</b> 24905130	

a - partly length 850 mm, (from -79)



25.07.2008



TRACTOR MODEL	BUSH		KING PIN TOP/BOTTOM	KING PIN BEARING OILSEAL	KNOCKLE		SHAFT FRONT
	FRONT	REAR			RIGHT	LEFT	
<b>580, 680 (a) 780 later model</b>	<b>T3193</b> 5101112	<b>T3346</b> 5129385	<b>T3652</b> 4997354	<b>L32006</b> 5109555 <b>OAS50627</b> 5122548			
<b>580, 680, 780</b>	<b>T3193</b> 5101112	<b>T3346</b> 5129385	<b>T3189</b> 5121116	<b>LM86649-610</b> <b>OA56708</b> 5121471			<b>T3586</b> 5131122
<b>880 4-cyl., 880 5-cyl., 980</b>	<b>T3193</b> 5101112	<b>T3346</b> 5129385	<b>T3189</b> 5121116	<b>LM86649-610</b> <b>OA56708</b> 5121471	<b>T3439</b> 4994186		
<b>1180, 1380, 1580, 1880</b>	<b>T3193</b> 5101112	<b>T3346</b> 5129385	<b>T3188</b> 5120531	<b>L32208</b> 5119660			
<b>55-90, 60-90</b>	<b>T3193</b> 5101112	<b>T3346</b> 5129385					
<b>65-90</b>	<b>T3193</b> 5101112	<b>T3346</b> 5129385					<b>T3715</b> 5126631
<b>70-90, 80-90</b>	<b>T3193</b> 5101112	<b>T3346</b> 5129385	<b>T3189</b> 5121116	<b>LM86649-610</b> <b>OA56708</b> 5121471	<b>T3597</b> 5126939		<b>T3586</b> 5131122
<b>90-90, 100-90, 110-90</b>	<b>T3193</b> 5101112	<b>T3346</b> 5129385	<b>T3189</b> 5121116	<b>LM86649-610</b> <b>OA56708</b> 5121471	<b>T3599</b> 5127197	<b>T3598</b> 5127196	
<b>115-90, 130-90, 140-90, 160-90</b>	<b>T3193</b> 5101112	<b>T3346</b> 5129385	<b>T3188</b> 5120531	<b>L32208</b> 5119660			

a - later model = king pin is smaller



## FRONT AXLE HYDRAULIC DIFFERENTIAL LOCK

**T3585**

5142829

- 1380, 1580, 1880, 115-90, 130-90, 140-90, 160-90, 180-90

25.07.2008



TRACTOR MODEL	FRONT HUB SEAL	OUTER DRIVE SHAFT SEAL	INNER DRIVE SHAFT SEAL	HUB BEARING INNER	HUB BEARING OUTER
580 old, 680 old, 780 old		<b>FT5133799</b> 5133799	<b>FT5116701</b> 5116701		
1300	<b>FT5136003</b> 5136003		<b>FT5136002</b> 5136002	<b>L32015</b> 24903480	<b>L32016</b> 24903490
640, 650	<b>FT5107808</b> 5107808		<b>FT5105948</b> 5105948		
580, 680, 780	<b>FT5136004</b> 5136004	<b>FT5133799</b> 5133799	<b>FT5136002</b> 5136002	<b>L32014</b> 24903470	<b>L32014</b> 24903470
880, 880-5, 980	<b>FT5136003</b> 5136003	<b>FT5135990</b> 5135990	<b>FT5136002</b> 5136002	<b>L32015</b> 24903480	<b>L32016</b> 24903490
1180, 1380, 1580, 1880	<b>FT5107808</b> 5107808		<b>FT5105948</b> 5105948	<b>L32016</b> 24903490	
55-90, 60-90	<b>FT5135387</b> 5135387	<b>FT5116717</b> 5116717	<b>FT5116701</b> 5116701		
65-90			<b>FT5116701</b> 5116701		
70-90, 80-90	<b>FT5136004</b> 5136004	<b>FT5133799</b> 5133799	<b>FT5136002</b> 5136002	<b>L32014</b> 24903470	<b>L32014</b> 24903470
90-90, 100-90	<b>FT5136003</b> 5136003	<b>FT5135990</b> 5135990	<b>FT5136002</b> 5136002	<b>L32015</b> 24903480	<b>L32016</b> 24903490
110-90	<b>FT5137109</b> 5137109	<b>FT5133799</b> 5133799			
115-90, 160-90, 180-90	<b>FT5107808</b> 5107808	<b>FT5135990</b> 5135990	<b>FT5105948</b> 5105948	<b>L32016</b> 24903490	
130-90, 140-90	<b>FT5107808</b> 5107808	<b>FT5135990</b> 5135990	<b>FT5105948</b> 5105948	<b>L32016</b> 5133737	<b>L32018</b> 5133737
F110	<b>FT5137109</b> 5137109				

NOTE! Always check dimensions!

## FRONT PINION SEAL

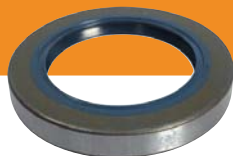

### FT5111415

5111415  
- 57 x 85 x 12  
- fits: 70-90, 80-90, 100-90, 110-90, 115-90, 130-90, 140-90, 160-90, 180-90, F120, F130, F140, M135, M160

## FRONT HUB SEAL



### FT5133736

5133736  
- inner  
- 190 x 220 x 21  
- fits: 115-90, 130-90, 140-90, 160-90, 180-90, 8360, 8430, 8560, 8630, 8830, M135, M160, TL100, TL80, TL90

25.07.2008

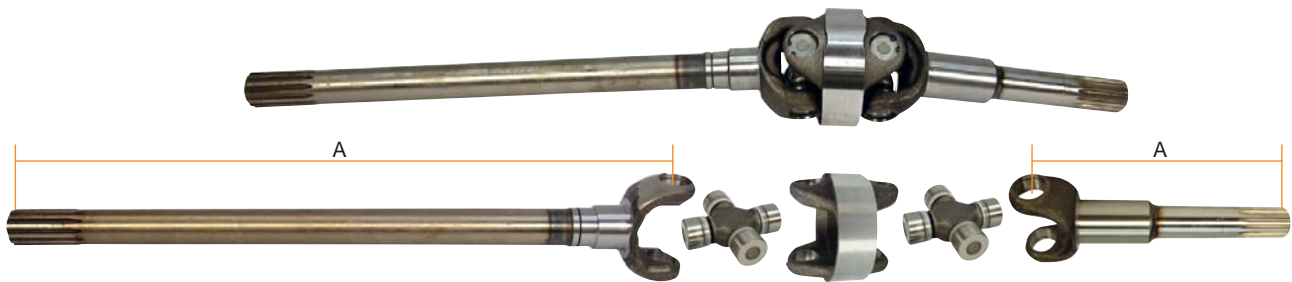

580, 680, 780 (parts fit, complete drive shaft not) 55-90, 60-90, 65-90			Dim. A	Spli- nes
<b>T3031</b>	9928667	Middle part		
<b>CR277</b>	4552009	Universal joint 27,00 x 74,60 mm		
<b>CR048</b>		Universal joint 27,00 x 74,60 mm with grease nipple		
<b>T3180</b>	9956515	Front wheel drive shaft inner	526 mm	10
<b>T3181</b>	9956516	Front wheel drive shaft inner	580 mm	10
<b>T3386</b>	9928665	Front wheel drive shaft outer	94 mm	15

880, 980 70-90, 80-90, 90-90, 100-90, 110-90 F100, F110, F115, 84-94			Dim. A	Spli- nes
<b>T3688</b>	5114993	Drive shaft complete right		12/13
<b>T3184</b>	9930899	Middle part		
<b>T3387</b>	9962244	Universal joint 27,00 x 81,70 mm (original) 9962244		
CR392(a)	9923550	Universal joint 27,00 x 81,70 mm		
<b>T3085</b>	9930900	Drive shaft left	607 mm	12
<b>T3086</b>	9930902	Drive shaft right	670 mm	12

580, 680, 780 70-90, 80-90, 90-90, 100-90, F100, F110, F115, 84-94			Dim. A	Spli- nes
<b>T3689</b>	5114991	Drive shaft complete left		12/14
<b>T3690</b>	5114989	Drive shaft complete right		12/14
<b>T3184</b>	9930899	Middle part		
<b>T3387</b>		Universal joint 27,00 x 81,70 mm (original) 9962244		
CR392(a)	9923550	Universal joint 27,00 x 81,70 mm		
<b>T3093</b>	9957397	Drive shaft left	531 mm	12
<b>T3094</b>	9957395	Drive shaft right	595 mm	12
<b>T3095</b>	9957396	Front wheel drive shaft outer	242 mm	14

8160, 8260, M100, M115, M160 F100, F115, 90-90, 100-90, 110-90			Dim. A	Spli- nes
<b>T3184</b>	9930899	Middle part		
<b>T3387</b>	9962244	Universal joint 27,00 x 81,70 mm (original) 9962244		
CR392(a)	9923550	Universal joint 27,00 x 81,70 mm		
<b>T3740</b>	5189163	Drive shaft complete right		12/14
<b>T3741</b>	5164853	Drive shaft complete right		12/14

1180, 1380, 1580, 1880 115-90, 130-90, 140-90, 160-90, 180-90			Dim. A	Spli- nes
<b>T3644</b>	9959702	Middle part		
<b>CR098</b>	9959701	Universal joint 30,17x92,00 mm		
<b>T3641</b>	9959704	Front wheel drive shaft	640 mm	14
<b>T3642</b>	9959703	Drive joint	249 mm	14

1180, 1380, 1580, 1880 115-90, 130-90, 140-90, 160-90, 180-90			Dim. A	Spli- nes
<b>T3644</b>	9959702	Middle part		
<b>CR098</b>	9959701	Universal joint 30,17x92,00 mm		
<b>T3645</b>	9959692	Front wheel drive shaft right	696 mm	14

a - no grease nipple in the joint, endures greater load

08.05.2009

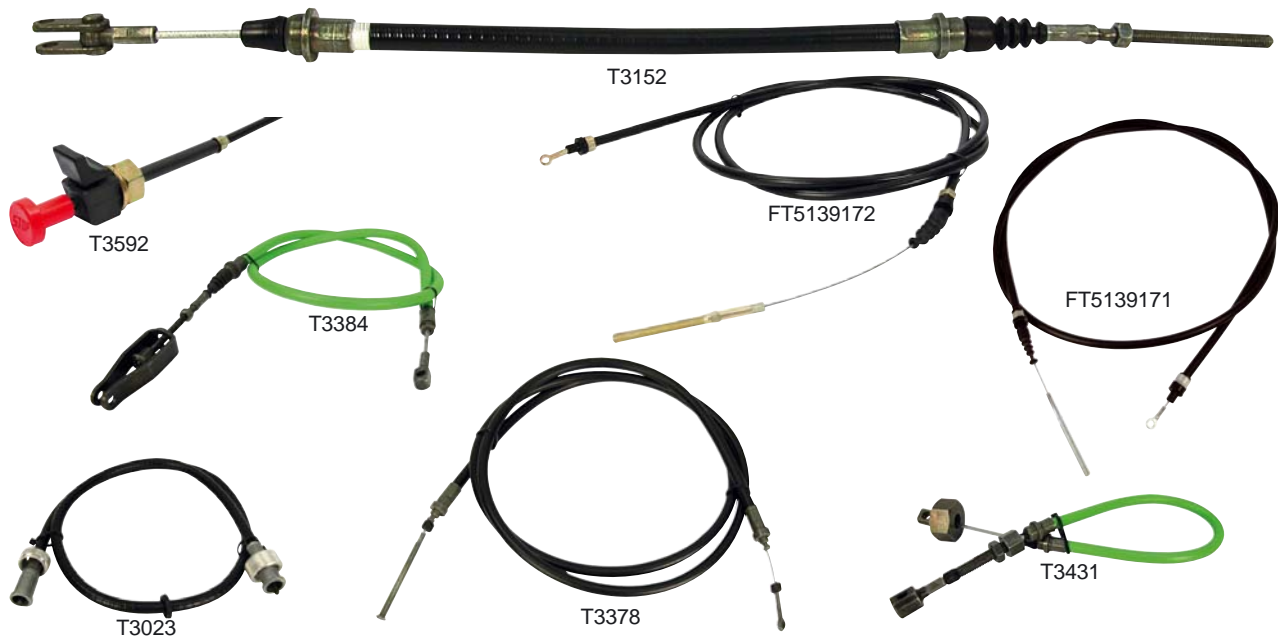

TRACTOR MODEL	PULL TO STOP CABLE	HOUR METER CABLE	HAND THROTTLE CABLE	CONTROL SWITCH CABLE	P.T.O. CLUTCH CABLE	HYDR. LIFT CONTROL CABLE	HAND BRAKE CABLE
640		<b>T3023</b> 4976720					
750, 850		<b>T3325</b> 4976739					
1000		<b>T3331</b> 4976770					
580		<b>T3023</b> 4976720	<b>T3066</b> 5149955	<b>T3065</b> 5115686	<b>T3064</b> 5101694	<b>T3036</b> 4999388	
680	<b>T3592</b> 5153380	<b>T3023</b> 4976720	<b>T3066</b> 5149955	<b>T3065</b> 5115686	<b>T3064</b> 5101694	<b>T3036</b> 4999388	
780	<b>T3592</b> 5153380	<b>T3023</b> 4976720	<b>T3066</b> 5149955	<b>T3065</b> 5115686	<b>T3064</b> 5101694	<b>T3036</b> 4999388	
880 4-cyl.	<b>T3592</b> 5153380	<b>T3325</b> 4976739	<b>T3066</b> 5149955	<b>T3152</b> 5120399	<b>T3126</b> 5101695	<b>T3036</b> 4999388	
880 5-cyl., 980	<b>T3593</b> 5153381	<b>T3023</b> 4976720	<b>T3066</b> 5149955	<b>T3152</b> 5120399	<b>T3126</b> 5101695	<b>T3036</b> 4999388	
1180	<b>T3593</b> 5153381		<b>T3378</b> 5149956				<b>T3431</b> 5111687
1380	<b>T3592</b> 5153380		<b>T3378</b> 5149956				<b>T3431</b> 5111687
1580	<b>T3593</b> 5153381	<b>T3329</b> 5112653	<b>T3378</b> 5149956				<b>T3431</b> 5111687
1880		<b>T3329</b> 5112653	<b>T3378</b> 5149956				<b>T3431</b> 5111687
55-90, 60-90, 70-90, 80-90		<b>T3023</b> 4976720	<b>T3378</b> 5149956	<b>T3152</b> 5120399	<b>T3384</b> 5126567	<b>FT5139172</b> (a) 5139172	<b>T3430</b> 5125736
90-90		<b>T3023</b> 4976720	<b>T3378</b> 5149956	<b>T3152</b> 5120399	<b>T3385</b> 5131252	<b>FT5139172</b> (a) 5139172	<b>T3431</b> 5111687
100-90, 110-90		<b>T3023</b> 4976720	<b>T3378</b> 5149956	<b>T3152</b> 5120399	<b>T3385</b> 5131252	<b>FT5139172</b> (a) 5139172	<b>T3431</b> 5111687
115-90, 130-90, 140-90	<b>T3592</b> 5153380	<b>T3330</b> 4976718	<b>T3378</b> 5149956			<b>FT5139171</b> 5139171	<b>T3431</b> 5111687
160-90	<b>T3593</b> 5153381	<b>T3329</b> 5112653	<b>T3378</b> 5149956			<b>FT5139171</b> 5139171	<b>T3431</b> 5111687
180-90		<b>T3329</b> 5112653	<b>T3378</b> 5149956			<b>FT5139171</b> 5139171	<b>T3431</b> 5111687
8430, 8630, 8830						<b>FT5139171</b> 5139171	

a - FT5139172 hydr. lift control "Clic Clac" -cable

26.10.2007



TRACTOR MODEL	STARTER BOSCH TYPE	STARTER MARELLI TYPE	SOLENOID BOSCH	SOLENOID MARELLI	BENDIX WHEEL BOSCH TYPE	BENDIX WHEEL MARELLI
450, 500		<b>ST0220</b> 4682998		<b>ST0170</b> 9940366		
550, 600	<b>SM2505</b> 0001367028	<b>ST0172</b> 4807375	<b>ST0171</b> 20301070		<b>ST1027</b>	
640	<b>SM2505</b> 0001367028	<b>ST0172</b> 4807375	<b>ST0171</b> 20301070	<b>ST0170</b> 9940366	<b>ST1027</b>	<b>ST0189</b> 9986112
650, 750, 850, 1300		<b>ST0214</b> 4737758				
1000	<b>SM2505</b> 0001367028	<b>ST0172</b> 4807375	<b>ST0171</b> 20301070	<b>ST0170</b> 9940366	<b>ST1027</b>	<b>ST0189</b> 9986112
880 4-cyl.		<b>ST0214</b> 4737758	<b>ST0171</b> 20301070	<b>ST0170</b> 9940366		<b>ST0189</b> 9986112
680, 780, 880-5, 980, 1180	<b>SM2505</b> 0001367028	<b>ST0172</b> 4807375	<b>ST0171</b> 20301070	<b>ST0170</b> 9940366	<b>ST1027</b>	<b>ST0189</b> 9986112
880-5, 980, 1180, 1380, 1580	<b>SM2537</b> 0001367029	<b>ST0201</b> 4807376	<b>ST0171</b> 20301070	<b>ST0170</b> 9940366		<b>ST0189</b> 9986112
1880	<b>SM2537</b> 0001367029	<b>ST0201</b> 4807376		<b>ST0170</b> 9940366		<b>ST0189</b> 9986112
580, 55-90, 60-90		<b>ST0220</b> 4682998	<b>ST0171</b> 20301070	<b>ST0170</b> 9940366		<b>ST0189</b> 9986112 <b>ST0199</b> 4808498
70-90, 80-90, 82-94 65-90, 85-90, 88-94	<b>SM2505</b> 0001367028	<b>ST0172</b> 4807375		<b>ST0170</b> 9940366	<b>ST1027</b>	<b>ST0189</b> 9986112
90-90, 100-90, 115-90	<b>SM2537</b> 0001367029	<b>ST0201</b> 4807376		<b>ST0170</b> 9940366		<b>ST0189</b> 9986112
130-90, 140-90, 110-90 160-90, 180-90	<b>SM2537</b> 0001367029	<b>ST0201</b> 4807376		<b>ST0170</b> 9940366		<b>ST0189</b> 9986112
NEW HOLLAND M-series	<b>ST0235</b> 82005342					
L65, L75, L85, L95	<b>SM2505</b> 0001367028	<b>ST0172</b> 4807375		<b>ST0170</b> 9940366	<b>ST1027</b>	<b>ST0189</b> 9986112

## ALTERNATORS



### ST0169

4746400  
- 55 Ah  
- 640, 580-1580  
(55-90, 60-90 partly)



### ST0198

4222697  
- 42 Ah  
- 650, 750, 850, 1000, 1300



### ST0199

4808498  
- 65 Ah  
- with w-connector  
- 65-90, 70-90, 80-90,  
90-90, 82-94, 88-94  
(55-90, 60-90 partly)



### ST0200

4808517  
- 65 Ah  
- with w-connector  
- 90-90, 100-90, 115-90,  
130-90, 140-90, 110-90





## STARTER SWITCH

### T3514

4158641, 5118483  
- 450, 500, 550, 600, 640, 650, 750, 850, 1000, 1300



## STARTER SWITCH

### T3190

4998108, 5112124, 5122727  
- 580, 680, 780, 880, 980, 1180, 1380, 1580, 1880, 60-90, 65-90, 65-94, 70-56, 70-66, 70-90, 80-66, 80-90, 82-93, 82-94, 85-90, 88-94, 90-90, 100-90, 110-90, 115-90, 130-90, 140-90, 160-90, 180-90



## STARTER SWITCH

### T3755

5154401  
- 23/950-30  
- F100, F110, F115, F120, F130, F140, L60, L65, L75, L85, L95



## LIGHT SWITCH

### T3582

4998107, 5125958  
- 580, 680, 780, 880-4, 880-5, 980, 1180, 1380, 1580, 1880



## LIGHT SWITCH

### T3705

5126126  
- 55-90, 60-90, 65-90, 70-90, 80-90, 85-90, 90-90, 100-90, 115-90, 130-90, 140-90, 160-90, 180-90



## GLOW SWITCH

### T3707

5176282  
- 55-90, 60-90, 65-90, 70-90, 80-90, 85-90, 90-90, 100-90, 115-90, 130-90, 140-90, 160-90, 180-90



## WORK LIGHT SWITCH

### T3706

9957649  
- 55-90, 60-90, 65-90, 70-90, 80-90, 85-90, 90-90, 100-90, 115-90, 130-90, 140-90, 160-90, 180-90



## MULTI-PURPOSE SWITCH LEFT

### T3967

5126127  
- 115-90, 130-90, 140-90, 160-90, 180-90



## MULTI-PURPOSE SWITCH RIGHT

### T3698

5129345  
- 55-90, 60-90, 65-90, 70-90, 80-90, 85-90, 90-90, 100-90, 110-90

### Note!

For more blinker relays see Accessories catalogue section 2



## BLINKER RELAY

### ST0260

5125586  
- universal model

25.07.2008



## FRONT LIGHT

### T3617

5137933  
- rounded, complete  
- fits 580-1880



## FRONT LIGHT

5138349  
- rectangle, complete  
- fits 580-1880,  
55-90 - 180-90



## FRONT SIDE LIGHT RIGHT

### F0658

5146291  
- fits: L60, 65, 75, 85, 95  
M100, 115, 135, 160  
TM115, 120, 125, 130, 135,  
140, 150, 155, 165, 175,  
190, TS90, 100, 110, 115

## FRONT SIDE LIGHT LEFT

### F0659

5146292  
- fits: L60, 65, 75, 85, 95  
M100, 115, 135, 160  
TM115, 120, 125, 130, 135,  
140, 150, 155, 165, 175,  
190, TS90, 100, 110, 115



## REAR LIGHT LEFT

### T3046

4997266  
- pininfarina, cabina larga, 100-90, 110-90, 115-90, 1180,  
1280, 130-90, 1380, 140-90, 1580, 160-90, 1880, 446,  
45-66, 466, 50-66, 55-66, 55-90, 566, 580, 60-66, 60-90,  
60-93, 60-94, 65-66, 65-90, 65-93, 65-94, 666, 680, 70-66,  
70-90, 72-93, 72-94, 766, 780, 80-66, 80-90, 82-93, 82-94,  
85-90, 880, 880-5, 88-93, 88-94, 90-90, 980  
- spare glass T3044



## REAR LIGHT RIGHT

### T3047

4997267  
- pininfarina, cabina larga, 100-90, 110-90, 115-90, 1180,  
1280, 130-90, 1380, 140-90, 1580, 160-90, 1880, 446,  
45-66, 466, 50-66, 55-66, 55-90, 566, 580, 60-66, 60-90,  
60-93, 60-94, 65-66, 65-90, 65-93, 65-94, 666, 680, 70-66,  
70-90, 72-93, 72-94, 766, 780, 80-66, 80-90, 82-93, 82-94,  
85-90, 880, 880-5, 88-93, 88-94, 90-90, 980  
- spare glass T3045



## REAR LIGHT

### F0660

82008066  
- fits: L60, 65, 75, 85, 95

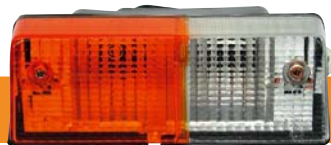

## FRONT LIGHT

- pininfarina cabin, 100-90, 110-90, 115-90, 1180, 1280, 130-90, 1380, 140-90, 1580,  
160-90, 1880, 446, 45-66, 466, 50-66, 55-66, 55-90, 566, 580, 60-66, 60-90, 60-93, 60-94,  
65-66, 65-90, 65-93, 65-94, 666, 680, 70-66, 70-90, 72-93, 72-94, 766, 780, 80-66, 80-90,  
82-93, 82-94, 85-90, 880, 880-5, 88-93, 88-94, 90-90, 980

### Left

#### T3041

4999858  
- spare glass left T3042

### Right

#### T3040

4999859  
- spare glass left T3043

## FRONT LIGHT

- cabina larga cabin

### Left

#### T3579

5116239  
- spare glass right/left T3581



### Right

#### T3580

5116238



## HEAD LAMP

### F0657

5112013  
- fits:  
L60, 65, 75, 85, 95  
TL70, 80, 90, 100



## FUSE BOX

### T3753

4998859  
- fits: 90, 94 series  
- for 12 fuses

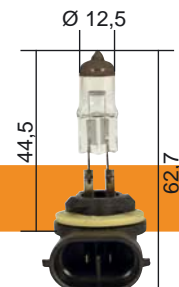

## BULB

### P12886

8200449  
- for work light New Holland M-series  
- 12,8V, 50W  
- base PGJ13

08.05.2009



## DOOR LOCK AND INNER HANDLE

- 580-1880, 55-90 - 180-90  
- all models with "Pininfarina" cabin

**Left**  
**T3080**

5108380

**Right**  
**T3081**

5108381



## HANDLE ASSEMBLY OUTER

- 580-1880, 55-90 - 180-90  
- all models with "Pininfarina" cabin

**Left**  
**T3076**

5108382

**Right**  
**T3077**

5108392

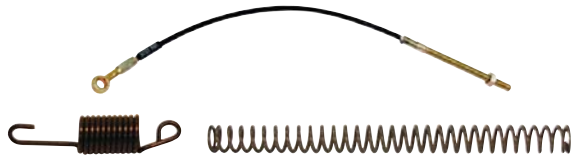

## DOOR STOP

**Spring**  
**FT5108410**

5108410  
- 80-series

**Cable**  
**FT5120144**

5120144  
- 90-94 series

**Spring**  
**FT5120172**

5120172  
- 90-94 series

## CABIN RUBBER PAD



**T3090**

4997423

- 100-90, 110-90, 4635, 4835, 55-88, 55-90, 5635, 60-88, 60-90, 60-93, 60-94, 65-88, 65-90, 65-93, 65-94, 6635, 70-80, 70-90, 72-93, 72-94, 7635, 80-88, 80-90, 82-93, 82-94, 85-90, 88-93, 88-94, 90-90, L60, L65, L75, L85, L95, TL100, TL70, TL80, TL90



## GEAR DRIVE FOR HOUR METER

**T3752**

598816, 5109356

- 466, 566, 580, 666, 680, 780, 880, 980, 35-66, 45-66, 50-66, 55-46, 55-66, 55-88, 55-90, 60-46, 60-66, 60-76, 60-86, 60-90, 60-93, 60-94, 65-46, 65-56, 65-66, 65-88, 65-90, 65-93, 65-94, 70-56, 70-66, 70-88, 72-86, 72-93, 72-94, 80-66, 80-76, 80-88, 80-90, 82-86, 82-93, 82-94, 85-90, 88-93, 88-94, 90-90, 100-90, 110-90, 115-90, 130-90, 140-90, F100, F110, F115, F120, F130, F140, L60, L65, L75, L85, L95



## FRONT GRILL

**T3060**

5175979

- for rectangle light  
- painted  
- fits 580-980, 55-90 - 100-90



## HEATER FAN MOTOR

**T3565**

- 580-1880, 55-90 - 180-90  
- all models with "Pininfarina" cabin  
- resistor **T3565A**

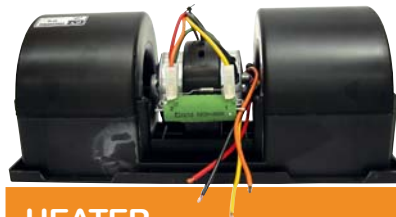

## HEATER FAN MOTOR

**F0654**

82034854  
- fits: M100, 115, 135, 160  
TM115, 120, 125, 130, 140

## HEATHER TAP

**T3751**

9961515  
- 90-94-series



25.07.2008



## MIRROR WITH ARM

- 80 and 90 -series
- includes fastening piece

**Left**  
**T3634**

5108722

**Right**  
**T3633**

5108721

**Mirror**  
**T1527**

5126233



## SUN ROOF HANDLE

**T3082**

5178614

- 580-1880, 55-90 - 180-90
- all models with "Pininfarina" cabin



## MIRROR

**F0599**

82014840

- NH 60 and M series, TM175, 190, TS110, 115, 125A, 130A, 135A
- spare mirror F0601

## MIRROR ARM

**Left**  
**F0595**

82014839

**Right**  
**F0596**

82014838



## MIRROR

**F0600**

82014587

- NH 60-, -70, M, TM- and TS-series
- spare mirror T2420

## TELESCOPIC MIRROR ARM

**Left**  
**F0597**

82014589

**Right**  
**F0598**

82014588

## REAR GLASS HANDLE

**T3708**

5113656, 5178432

- 580-1880, 55-90 - 180-90
- partly models with "Pininfarina" cabin



## REAR GLASS HINGE

**T3079**

5122998

- 580-1880, 55-90 - 180-90
- all models with "Pininfarina" cabin



## WIPER BLADE

**VLC3228**

5139806

- fits: 580, 680, 780, 880, 880-5, 980 pininfarina
- 1180, 1380 pininfarina, 1580, 1880 (pininfarina)
- Fiatagri 55-90, 60-90, 65-90, 70-90, 80-90 narrow cabin
- Fiatagri 70-, 80-, 85-, 90-, 100-, 110-, 115-, 130-, 140-, 160-, 180-90 CL-cabins



## WIPER BLADE

**VLC3225**

5144385

- fits: Winner F100, F110, F120, F130, F140

25.07.2008



T3078



T3619



VPM1689

TRACTOR MODEL	REAR WINDOW STRUT	ROOF WINDOW STRUT	DOOR STRUT
580, 680, 780, 880, 880-5, 980 pininfarina	T3078 KS0113 5129427	T3619 KS0114 5125289	
1180, 1380 pininfarina	T3078 KS0113 5129427	T3619 KS0114 5125289	
1580, 1880 (pininfarina)	T3078 KS0113 5129427	T3619 KS0114 5125289	
Fiat-agri 55-90, 60-90, 65-90, 70-90, 80-90 narrow cabin	T3078 KS0113 5129427	T3619 KS0114 5125289	
Fiat-agri 70-, 80-, 85-, 90-, 100-, 110-, 115-, 130-, 140-, 160-, 180-90 CL-cabins	T3078 KS0113 5129427	T3619 KS0114 5125289	
Winner F100, F110, F120, F130, F140	KS0143 5153193	KS0144 5153206	VPM1689 KS0142 5147419



08.05.2009



## Fiatagri CS2 & CS2/1-cabins (Pininfarina)

580, 680, 780, 880, 980, 55-90 - 80-90

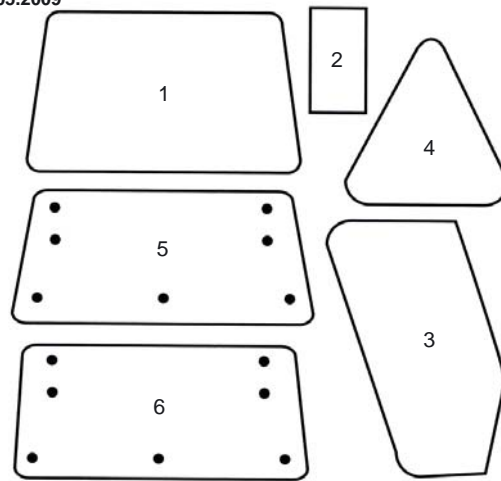

ORDER NUMBER	WINDOW NUMBER	DESCRIPTION	ORIGINAL PART NUMBER	SIZE mm (H x W x thickness)	TINT	FIXING
1	T3760 (d)	windscreen	5108663	1100 x 660 x 6	clear	GR
2	T3761 (d)	lower front	5108667	584 x 211 x 5	clear	GR
3	T3657	door	5108670/5108669	1165 x 565 x 4	clear	GR
4	T3762	side window	5108673	601 x 484 x 4	clear	GR
4	T3763	side window	5108674	601 x 484 x 4	clear	GR
5	T3583 (b)	upper rear	5108627	1088 x 600 x 6	clear	K/BLT
6	T3764 (a, c)	upper rear	5121385	1063 x 597 x 6	clear	K/BLT

- a - replaces number 5113393
- b - up to serial number →9000
- c - from serial number 9001→
- d - 55-90 - 80-90 with Pininfarina cabin

Models above suit also for the following CS-cabin types, with the difference of tinted colour:

- 1 & 2 for cabin types CS8, 11 & 15
- 3 for cabin types CS5, 6, 8 & 9
- 4 for cabin types CS8
- 6 for cabin types CS8 & 15

## Fiatagri CS3-cabins

1180, 1280, 1380, 1580, 1880

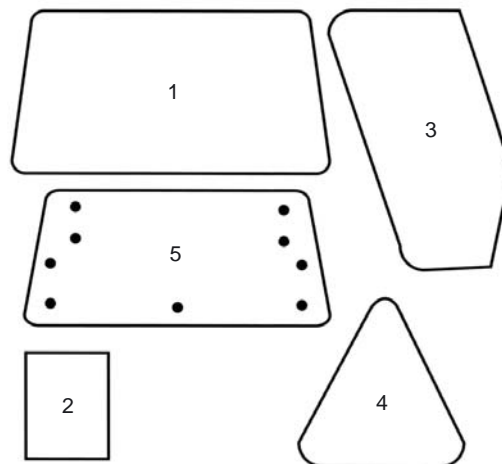

ORDER NUMBER	WINDOW NUMBER	DESCRIPTION	ORIGINAL PART NUMBER	SIZE mm (H x W x thickness)	TINT	FIXING
1	T3765	windscreen	5113401	1405 x 660 x 6	clear	GR
2	T3766	lower front	5113402	584 x 364 x 5	clear	GR
3	T3657	door	5108670/5108669	1165 x 565 x 4	clear	GR
4	T3762	side window	5108673	601 x 484 x 4	clear	GR
4	T3763	side window	5108674	601 x 484 x 4	clear	GR
5	T3767	upper rear	5113403	1367 x 595 x 6	clear	K/BLT

Models above suit also for the following CS-cabin types, with the difference of tinted colour:

- 1 & 2 for cabing types CS5, 6 & 9
- 3 for cabing types CS5, 6, 7, 8 & 9
- 4 for cabing type CS8
- 5 for cabing types CS5, 6 & 9

Fixing: B = bonded  
BLT = bolt on  
F = framed  
GR = glazing rubber  
K = knock on rubber

12.01.2009



## Fiatagri CL-cabins

70-90, 80-90, 90-90,  
100-90, 115-90, 180-90

Models above suit also for the following  
CL-cabin types with the difference  
of colour:

- 1 & 2 for cabin types CS5, 6 & 9
- 3 & 4 for cabin types CS15

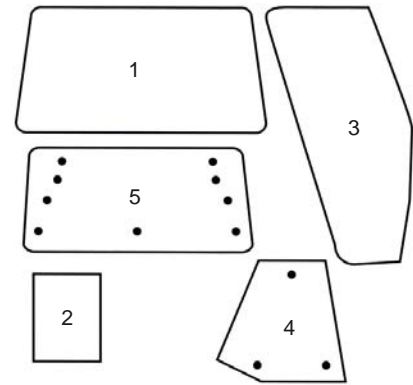

ORDER NUMBER	WINDOW NUMBER	DESCRIPTION	ORIGINAL PART NUMBER	SIZE mm (H x W x thickness)	TINT	FIXING	
1	<b>T3765</b>	windscreen	5113401	1405 x 660 x 6	clear	GR	
2	<b>T3766</b>	lower front	left & right	584 x 364 x 5	clear	GR	
3	<b>T3658</b>	door	left & right, curved	5130884/5130883	1355 x 540 x 4	tinted	GR
4	<b>T3768 (a)</b>	side window	left & right, 3 holes	5165571	598 x 555 x 4	tinted	K/BLT
5	<b>T3584</b>	upper rear	9 holes	5130388	1367 x 595 x 6	clear	K/BLT

a - replaces numbers 5130773 & 5130895

## Fiat Winner

### REAR WINDOW

**T3701**

5154756

- Fiat Winner F100, F110, F120, F130, F140

### DOOR WINDOW

**T3702**

5154934

- Fiat Winner F100, F110, F120, F130, F140



## L-series

60, 65, 75, 85, 95

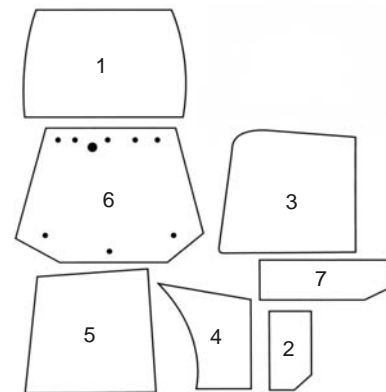

ORDER NUMBER	WINDOW NUMBER	DESCRIPTION	ORIGINAL PART NUMBER	SIZE mm (H x W x thickness)	TINT	FIXING	
1	<b>F0635</b>	windscreen	fixed, curved	82002183	1154 x 827 x 5	tinted	B
2	<b>F0636</b>	lower front	right	82002184	652 x 340 x 5	tinted	B
2	<b>F0637</b>	lower front	left	82002185	652 x 340 x 5	tinted	B
3	<b>F0638</b>	upper door	right, curved	82002179	870 x 782 x 5	tinted	B
3	<b>F0639</b>	upper door	left, curved	82002180	870 x 782 x 5	tinted	B
4	<b>F0640</b>	lower door	right	82002181	787 x 630 x 5	tinted	B
4	<b>F0641</b>	lower door	left	82002182	787 x 630 x 5	tinted	B
5	<b>F0642</b>	side window	right, curved	82002229	780 x 652 x 5	tinted	B
5	<b>F0643</b>	side window	left, curved	82002230	780 x 652 x 5	tinted	B
6	F82005316 (a)	upper rear	9 holes	5178304	1503 x 905 x 5	tinted	K/BLT
7	<b>F0644</b>	lower rear		82000485	703 x 299 x 5	tinted	B

a - replaces number 82005316

Fixing: B = bonded  
BLT = bolt on

F = framed  
GR = glazing rubber  
K = knock on rubber

**C1.46**

## TL-series 70, 80, 90, 100

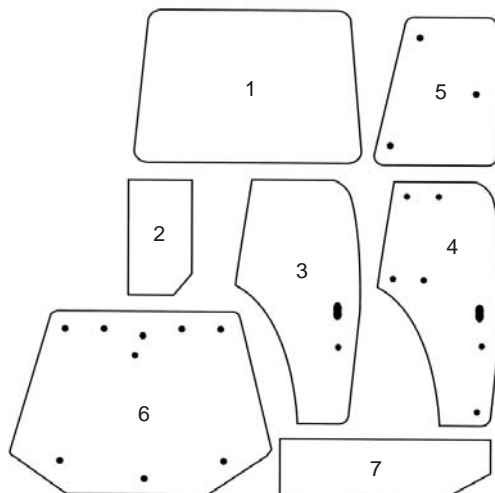

	ORDER NUMBER	WINDOW	DESCRIPTION	ORIGINAL PART NUMBER	SIZE mm (H x W x thickness)	TINT	FIXING
1	F0635	windscreen	curved	82002183	1154 x 827 x 5	tinted	B
2	F0636	lower front	right	82002184	652 x 340 x 5	tinted	B
2	F0637	lower front	left	82002185	652 x 340 x 5	tinted	B
3	F0630 (a)	door	left, 2 holes, curved	82000396	1492 x 842 x 5	tinted	B
3	F0631 (a)	door	right, 2 holes, curved	82000367	1492 x 842 x 5	tinted	B
4	F0604 (b)	door	right, 7 holes, curved	82019225	1560 x 875 x 5	tinted	BLT
4	F0603 (b)	door	left, 7 holes, curved	82019226	1560 x 875 x 5	tinted	BLT
5	F0648	side window	left, 3 holes, curved	5182189	725 x 637 x 5	tinted	BLT
5	F0649	side window	right, 3 holes, curved	5182188	725 x 637 x 5	tinted	BLT
6	F82005316 (c)	upper rear	9 holes	5178304	1503 x 905 x 5	tinted	K/BLT
7	F0644	lower rear		82000485	703 x 299 x 5	tinted	B

a - door with frame b - without frame c - 11/95 → distance of bottom holes 1077 mm

## TM-series 115, 125, 135, 150, 165

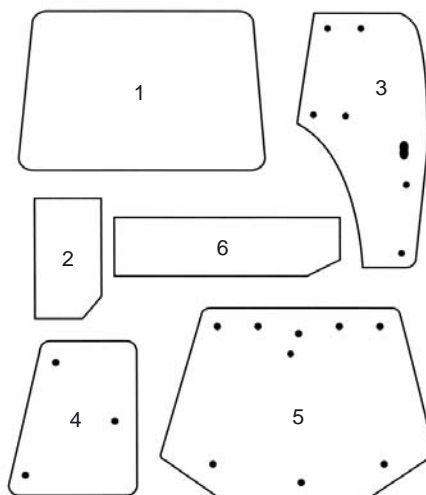

	ORDER NUMBER	WINDOW	DESCRIPTION	ORIGINAL PART NUMBER	SIZE mm (H x W x thickness)	TINT	FIXING
1	F0645	windscreen	curved	82000296	1154 x 840 x 5	tinted	B
2	F0646	lower front	right	82001924	652 x 340 x 6	tinted	B
2	F0647	lower front	left	82001923	652 x 340 x 6	tinted	B
3	F0604	door	right, 7 holes, curved	82019225	1560 x 875 x 5	tinted	BLT
3	F0603	door	left, 7 holes, curved	82019226	1560 x 875 x 5	tinted	BLT
4	F0632	side window	left, 3 holes, curved	82009813	775 x 650 x 5	tinted	BLT
4	F0633	side window	right, 3 holes, curved	82009812	775 x 650 x 5	tinted	BLT
5	F82005316	upper rear	9 holes	82014988	1503 x 905 x 5	tinted	K/BLT
6	F0644	lower rear		82000485	703 x 299 x 5	tinted	B

Fixing: B = bonded BLT = bolt on F = framed

GR = glazing rubber

K = knock on rubber

**C1.47**

08.01.2007

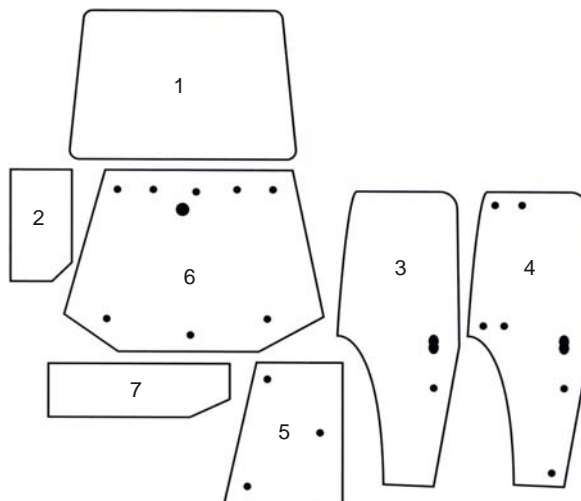

## Fiatagri M-series

100, 115, 135, 160

	ORDER NUMBER	WINDOW	DESCRIPTION	ORIGINAL PART NUMBER	SIZE mm (H x W x thickness)	TINT	FIXING
1	F0645	windscreen	fixed, curved	82000296	1154 x 840 x 5	tinted	B
2	F0646	lower front	right	82001924	652 x 340 x 6	tinted	B
2	F0647	lower front	left	82001923	652 x 340 x 5	tinted	B
3	F0630 (d)	door	right, 2 holes, curved	82000396	1492 x 842 x 5	tinted	B
3	F0631 (d)	door	right, 2 holes, curved	82000367	1492 x 842 x 5	tinted	B
4	F0604	door	right, 7 holes, curved	82019225	1560 x 875 x 5	tinted	BLT
4	F0603	door	left, 7 holes, curved	82019226	1560 x 875 x 5	tinted	BLT
5	F0632 (a)	side window	right, 3 holes, curved	82009813	775 x 650 x 5	tinted	BLT
5	F0633 (b)	side window	left, 3 holes, curved	82009812	775 x 650 x 5	tinted	BLT
6	F82005316 (c,e)	upper rear	9 holes	5178304	1503 x 905 x 5	tinted	K/BLT
7	F0644	lower rear		82000485	703 x 299 x 5	tinted	B

- a - replaces number 83995322
- b - replaces number 83995321
- c - replaces number 82005316
- d - with frame not imported to Finland
- e - 11/95 → distance of bottom holes 1077 mm

- Fixing:
- B = bonded
  - BLT = bolt on
  - F = framed
  - GR = glazing rubber
  - K = knock on rubber

## WINDSCREEN GLUE SET

### HK269

- dispensed cold, non-drip
- max. sticking time 25 min
- ready for driving in 2 hours
- set includes: cleaning agent 20 ml, cleaning linen, primer 10 ml, primer-spreader, glue 310 ml



C1.48



25.07.2008

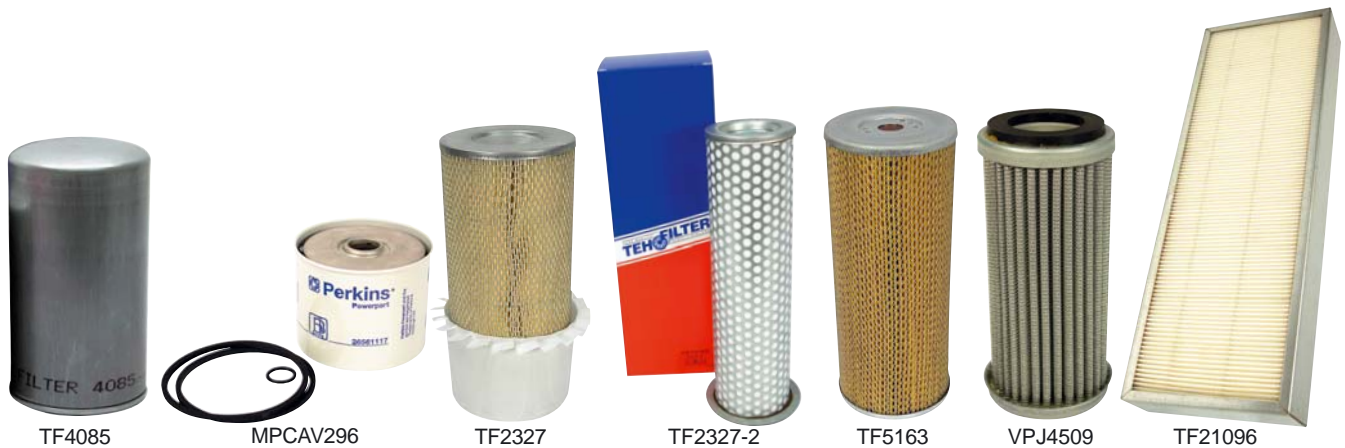

TRACTOR MODEL	OIL FILTER	FUEL FILTER	AIR FILTER OUTER	AIR FILTER INNER	HYDRAULIC FILTER	STEERING FILTER	CABIN FILTER
18		<b>TF7077</b> 1909112					
25R, 215	<b>TF5006</b> 1909104	<b>TF7077</b> 1909112					
211, 311, 312 411, 441	<b>TF5006</b> 1909104	<b>TF7022</b> (x1) 1909108 <b>TF7077</b> (x1) 1909112					
250, 300	<b>TF4076</b> <b>FT1909102</b> 1909102	<b>TFCAV296</b> <b>MPCAV296</b> 1909100					
315	1909110	<b>TF7077</b> 1909112					
415	<b>TF5006</b> 1909104	<b>TF7022</b> (x1) 1909108 <b>TF8018</b> (x1) 1909113					
450, 500, 550, 600, 640	<b>TF4085</b> 1909101	<b>TFCAV296</b> (x2) <b>MPCAV296</b> (x2) 1909100					
513R, 615	<b>TF5041</b> 1909123						
650, 750, 850	<b>TF4085</b> 1909101	<b>TF6099</b> 1909103					
1000, 1000S	<b>TF4076</b> (x2) <b>FT1909102</b> 1909102	<b>TFCAV296</b> (x2) <b>MPCAV296</b> (x2) 1909100					
1300, 1300S	<b>TF4085</b> (x2) 1909101	<b>TF6099</b> 1909103 <b>FT1909107</b> 1909107					
480	<b>TF4085</b> 1909101	<b>TFCAV296</b> (x2) <b>MPCAV296</b> (x2) 1909100					
580, 680, 780, 880	<b>TF4085</b> 1909101	<b>TFCAV296</b> (x2) <b>MPCAV296</b> (x2) 1909100	<b>TF2327</b> 1909116	<b>TF2327-2</b> 1909117	<b>TF5163</b> 1909106	<b>VPJ4509</b> (h) 1909143	<b>TF21096</b> (x2) 1930782 <b>TF21124</b> (m)
880/5, 980	<b>TF4076</b> (x2) <b>FT1909102</b> 1909102	<b>TFCAV296</b> (x2) <b>MPCAV296</b> (x2) 1909100 <b>TF6206</b> (x2) 1930010	<b>TF2327</b> 1909116	<b>TF2327-2</b> 1909117	<b>TF5163</b> 1909106	<b>VPJ4509</b> (h) 1909143	<b>TF21096</b> (x2) 1930782

See remarks on page C1.52





# FIAT, FIATAGRI, NEW HOLLAND FILTERS



25.07.2008



TF4085



MPCAV296



TF2327



TF2327-2



FT1930910



VPJ4509



TF21096

TRACTOR MODEL	OIL FILTER	FUEL FILTER	AIR FILTER OUTER	AIR FILTER INNER	HYDRAULIC FILTER	STEERING FILTER	CABIN FILTER
1180, 1380	TF4076 (x2) FT1909102	TFCAV296 (x2) MPCAV296 (x2) 1909100 TF6206 (x2) 1930010	TF2113 1909136	TF2113-2 1930175	TF4159 1909130	VPJ4509 (h) 1909143	TF21096 (x2) 1930782
1580, 1880	TF4117 1930544	TF6099 (x1) 1909103 FT1909107 (x1) 1909107	TF2113 1909136	TF2113-2 1930175	TF4159 (x2) 1909130	VPJ4509 (h) 1909143	TF21096 (x2) 1930782
55-90, 60-90 65-90	TF4085 1909101	TFCAV296 (x2) MPCAV296 (x2) 1909100 FT1930581 (a) 1930581	TF2342 1930138	TF2327-2 1909117	TF4159 1909130	VPJ4509 (h) 1909143	TF21096 (b) 1930782 FT5141540 (c) 5141540
70-90, 80-90	TF4085 1909101	TFCAV296 (x2) MPCAV296 (x2) 1909100 FT1930581 (a) 1930581	TF2342 (d) 1930138 TF2327 1909116	TF2327-2 1909117	TF4159 (x2) 1909130	VPJ4509 (h) 1909143	TF21096 (b) 1930782 FT5141540 (c) 5141540
85-90	TF4076 FT1909102 1909102	TFCAV296 (x2) MPCAV296 (x2) 1909100 FT1930581 (a) 1930581	TF2327 (f) 1930116 TF2701 (g) 1930589	TF2327-2 (f) 1930117 TF2677-2 (g) 1930590	TF4159 1909130	VPJ4509 (h) 1909143	FT5141540 (x2) 5141540
90-90	TF4076 (x2) FT1909102 1909102	TF6206 (x2) 1930010 FT1930581 (a) 1930581	TF2342 (d) 1930138 TF2327 1909116	TF2327-2 1909117	TF4159 1909130	VPJ4509 (h) 1909143	TF21096 (b) 1930782 FT5141540 (c) 5141540
100-90, 110-90	TF4076 (x2) FT1909102 1909102	TF6206 (x2) 1930010 FT1930581 (a) 1930581	TF2342 (d) 1930138 TF2327 1909116	TF2327-2 1909117	TF4159 1909130	VPJ4509 (h) 1909143	TF21096 (b) 1930782 FT5141540 (c) 5141540
115-90	TF4076 (x2) FT1909102 1909102	TFCAV296 (x2) MPCAV296 (x2) 1909100 FT1930581 (a) 1930581	TF2332 1930174	TF2113-2 1930175	TF4159 1909130	VPJ4509 (h) 1909143	TF21096 (b) 1930782 FT5141540 (c) 5141540
130-90, 140-90	TF4178 1930213	TFCAV296 MPCAV296 (x2) 1909100 FT1930581 (a) 1930581	TF2332 1930174	TF2113-2 1930175	TF4159 1909130	VPJ4509 (h) 1909143	TF21096 (b) 1930782 FT5141540 (c) 5141540
160-90, 180-90	TF4117 1930544	TF6099 (x1) 1909103 FT1909107 (x1) 1909107 FT1930581 (a) 1930581	TF2332 1930174	TF2113-2 1930175	TF4159 (x3) 1909130 FT1930910 1930910	VPJ4509 (h) 1909143	TF21096 (b) 1930782 FT5141540 (c) 5141540

See remarks on page C1.52

C1.50



# FIAT, FIATAGRI, NEW HOLLAND FILTERS



25.07.2008



TF4085



MPCAV296



FT1930605



TF2327-2



FT1930882



VPJ4509



F83994694

TRACTOR MODEL	OIL FILTER	FUEL FILTER	AIR FILTER OUTER	AIR FILTER INNER	HYDRAULIC FILTER	STEERING FILTER	CABIN FILTER
65-94, 82-94	TF4085 1909101	TFCV296 (x2) MPCAV296 (x2) 1909100 FT1930581 (a) 1930581	TF2593 1930587	DFP775300 1930588	TF4159 1909130		FT5141540 (x2) 5141540
88-94	TF4076 FT1909102 1909102	TFCV296 (x2) MPCAV296 (x2) 1909100 TF6206 1930010 FT1930581 (a) 1930581	TF2701 1930589	TF2677-2 1930590	TF4159 1909130		FT5141540 (x2) 5141540
F100, F110, F115 F120	TF4076 (x2) FT1909102 1909102	TF6206 (x2) 1930010 FT1930581 (a) 1930581	TF2701 1930589 FT1930605 (e) 1930605	TF2677-2 1930590 TF2327-2 (e) 1930825	FT1930882 1930882		TF21131 (x2) 5124932
F130, F140	TF4178 (x2) 1930213	TF6206 (x2) 1930010 FT1930581 (a) 1930581	TF21101 1930603	TF21101-1 1930790	FT1930882 1930882		TF21131 (x2) 5124932
L60	TF4085 1909101	TF6206 1930010 FT1930581 (a) 1930581	TF2593 (g) 1930587	DFP775300 (g) 1930588	FT1930986 1930986	VPJ4509 (h) 1909143	TF21182 (x2) 82012057 F83994694 (i) 83994694
L65, L75	TF4076 FT1909102 1909102	TF6206 1930010 FT1930581 (a) 1930581	TF2593 (g) 1930587	DFP775300 (g) 1930588	FT1930986(x2) 1930986	VPJ4509 (h) 1909143	TF21182 (x2) 82012057 F83994694 (i) 83994694
L85, L95	TF4076 FT1909102 1909102	TF6206 1930010 FT1930581 (a) 1930581	FT1930605 (f) 1930605 TF2701 (g) 1930589	TF2327-2 (f) 1930825 TF2677-2 (g) 1930590	FT1930986 (x2) 1930986	VPJ4509 (h) 1909143	TF21182 (x2) 82012057 F83994694 (i) 83994694
M100, M115	TF4015 81879134	F87840591 87840591 F87801341 (j) 87801341 F87840590 (k) 87840590	TF2567 82008600	VPD7112 82008601	DFP502224 82005016 F81863799 81863799		TF21182 (x2) 82012057 F83994694 (i) 83994694
M135, M160	TF4015 81879134	F87840591 87840591 F87801341 (j) 87801341 F87840590 (k) 87840590	F82008606 82008606	F82008607 82008607	DFP502224 82005016 F81863799 81863799		TF21182 (x2) 82012057 F83994694 (i) 83994694

See remarks on page C1.52

C1.51

Original manufacturers names and part numbers are quoted for reference purpose only and are not intended to infer that our replacement parts are used as original equipment. Tables contain partly reference pictures.



# FIAT, FIATAGRI, NEW HOLLAND FILTERS



08.05.2009



TF6206



FT1930605



TF2327-2



FT1930986



VPJ4509



F83994694

TRACTOR MODEL	OIL FILTER	FUEL FILTER	AIR FILTER OUTER	AIR FILTER INNER	HYDRAULIC FILTER	STEERING FILTER	CABIN FILTER
<b>TL70, TL80</b>	<b>TF4076</b> <b>FT1909102</b> 1909102	<b>TF6206</b> 1930010 <b>FT1930581</b> (a) 1930581	<b>TF2593</b> (g) 1930587	<b>DFP775300</b> (g) 1930588	<b>FT1930986</b> (x3) 1930986	<b>VPJ4509</b> (h) 1909143	<b>TF21182</b> (x2) 82012057 <b>F83994694</b> (i) 83994694
<b>TL90</b>	<b>TF4076</b> <b>FT1909102</b> 1909102	<b>TF6206</b> 1930010 <b>FT1930581</b> (a) 1930581	<b>TF2701</b> (g) 1930589 <b>FT1930605</b> (f) 1930605	<b>TF2677-2</b> (g) 1930590 <b>TF2327-2</b> (f) 1930825	<b>FT1930986</b> (x3) 1930986	<b>VPJ4509</b> (h) 1909143	<b>TF21182</b> (x2) 82012057 <b>F83994694</b> (i) 83994694
<b>TL100</b>	<b>TF4076</b> <b>FT1909102</b> 1909102	<b>TF6206</b> 1930010 <b>FT1930581</b> (a) 1930581	<b>TF2701</b> (g) 1930589 <b>FT1930605</b> (f) 1930605	<b>TF2677-2</b> (g) 1930590 <b>TF2327-2</b> (f) 1930825	<b>FT1930986</b> (x2) 1930986	<b>VPJ4509</b> (h) 1909143	<b>TF21182</b> (x2) 82012057 <b>F83994694</b> (i) 83994694
<b>G170, G190, G210, G240</b>	<b>TF4015</b> 81879134						

a - water trap filter

b - 2 pcs/tractor up to -88

c - 2 pcs/tractor from -88, plastic pin locking

d - conic end, suction pipe from the end of the box

e - with self-cleaning airfilter box

f - with steel airfilter box

g - with plastic airfilter box

h - tank suction filter

i - thin slip-on filter

j - later model of fuel pump on filter foot

k - secondary filter

m - white cabin

## COMPLETE DUEL FUEL FILTER

### F0560

83914074, D8NN9N074AA

- 1000, 115-90, 1180, 1280, 130-90, 1380, 140-90, 446, 450 Italian, 450R, 460, 466, 480, 500, 540, 550, 55-90, 566, 570, 580, 600, 60-66, 640, 65-66, 65-90, 65-93, 65-94, 666, 670, 680, 70-66, 70-90, 72-93, 72-94, 766, 780, 80-66, 80-66F, 80-76F, 80-90, 82-86F, 82-93, 82-94, 85-90, 880, 880-5, 88-93, 88-94, 900, 980



## COOLANT FILTER

### F83971970

83971970

- fits M100, M115, M135, M160



## CHANGE IN FILTER

To replace TF5163 filter with the filter TF4159 the following parts are needed:

### Connection nipple

**FT5116767**

5116767

### Filter foot

**FT5129631**

5129631

**C1.52**

## DUST COLLECTOR PRE-CLEANER ASSEMBLY

Pre-cleaner saves the ordinary airfilter of the machine. In the dust collector the air rotates and the impurities will stay on the bottom of the pre-cleaner. It must be cleaned time to time.

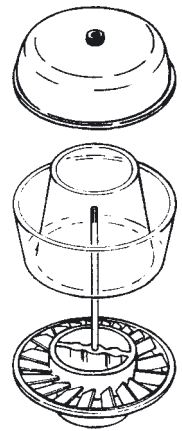

### DFH001249

- pipe 3"/76 mm
- spare bowl **DFP020227**

### DFH000820

- pipe 3"/76 mm
- spare bowl **DFP016330**

### DFH000822

- pipe 4"/101 mm
- spare bowl **DFP016330**

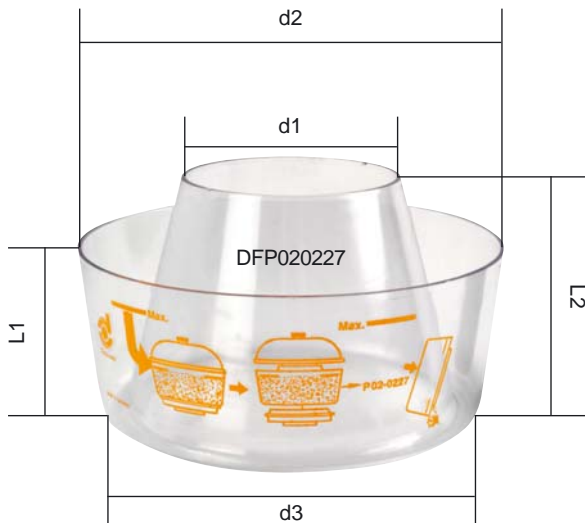

## SPARE BOWL DIMENSION TABLE

DIMENSIONS	DFP020227	DFP016330
d1 mm	90	141
d2 mm	183,5	266
d3 mm	140	217,5
L1 mm	77	75,5
L2 mm	106	101,5

## ALTERNATIVE IN ORIGINAL PACKAGE

<b>TF4076</b>	= FT1909102
<b>TF4085</b>	= FT1909101
<b>TF4159</b>	= FT1909130
<b>TF4178</b>	= FT1930213
<b>TF5163</b>	= FT1909106
<b>TF6206</b>	= FT1930010
<b>DFP502224</b>	= F82005016